

SUBMITTED BY:

R. A. Cullinan & Son, a Div. of
United Contractors Midwest, Inc.

CONTRACTOR'S NAME

121 W. Park St., P. O. Box 166

CONTRACTOR'S ADDRESS

Tremont, IL 61568

CITY, STATE, ZIP

STATE OF ILLINOIS

CITY OF PEORIA

COUNTY OF PEORIA

SPECIFICATIONS, PLANS, MATERIAL
QUANTITIES AND CONTRACT PROPOSAL

FOR

COLUMBINE DRIVE RECONSTRUCTION – NORTHTRAIL DRIVE TO
HICKORY GROVE ROAD

TO BE CONSTRUCTED UNDER THE PROVISIONS OF
THE CITY OF PEORIA

BID OPENING:

Thursday, June 16, 2016, 11:00 A.M.

CONTRACT AWARDED: JUNE 28, 2016 by City Council #16-217

Scott Reise, P.E., City Engineer

**CITY OF PEORIA
CONTRACT**

This agreement, made and entered into this _____ day of June, 2016, by and between the City of Peoria, an Illinois Municipal Corporation, Party of The First Part, and R.A. CULLINAN & SON, INC. A DIV. OF UNITED CONTRACTORS MIDWEST, INC., Party of The Second Part for the improvement known as the COLUMBINE DRIVE RECONSTRUCTION – NORTHTRAIL DRIVE TO HICKORY GROVE ROAD;

WITNESSETH: That for and in consideration of the payments and agreements mentioned in the proposal hereto attached, to be made and performed by the Party of The First Part, and according to the terms expressed in the bond referring to these presents, the Party of The Second Part agrees with said Party of The First Part, at his/their own proper cost and expense to furnish and deliver all the work, materials and supplies in accordance with the specifications contained in said proposal, and in full compliance with all the terms of this agreement, for the amount of FOUR HUNDRED THIRTY FOUR THOUSAND SEVEN HUNDRED THIRTY ONE AND 28/100 DOLLARS (\$434,731.28).

IT IS UNDERSTOOD AND AGREED that the instructions to bidders, proposal, bid, specifications, performance bond and maintenance bond are component parts of this contract and shall be deemed a part hereof. It is also understood and agreed that the contractor shall not assign, transfer, convey or otherwise dispose of this contract, or his right to execute it, or his right, title or interest in or to it or any part thereof, unless the previous written consent of the City Manager of the City of Peoria shall first be obtained thereto.

EMPLOYEE/EMPLOYMENT RESTRICTIONS – THE CONTRACTOR:

THE CONTRACTOR (hereinafter referred to as “SERVICE PROVIDER”) agrees, as a condition of accepting this contract with the City of Peoria, that, for a period of one (1) year following completion of this contract, it shall be prohibited from hiring, directly or indirectly, any City employee or official who was involved, directly or indirectly in: (1) the selection and/or recommendation to select the SERVICE PROVIDER for performance of this contract; (2) coordinating the efforts of the SERVICE PROVIDER in the consummation or completion of this contract; or (3) monitoring or determining the performance of the SERVICE PROVIDER. The SERVICE PROVIDER further acknowledges and agrees that, upon the City’s determination that a violation of this provision has occurred, the penalty imposed, at the sole discretion of the City, may include one or more of the following: (1) cancellation of any other contract(s) between the City of Peoria and the SERVICE PROVIDER; (2) disqualification of the SERVICE PROVIDER from bidding or being awarded future contracts with the City of Peoria for a period of two [2] years; and/or (3) payment of liquidated damages to the City of Peoria in the amount of TWENTY FIVE THOUSAND DOLLARS (\$25,000.00). This does not apply to any City Employee involved in the 2011-12 reduction in force; nor does it apply to parties taking the Early Retirement incentive offered by the City from November 1, 2011 through November 1, 2012.

IN WITNESS WHEREOF, the said parties have executed these presents on the date above mentioned.

THE CITY OF PEORIA

BY: _____

City Manager

ATTEST: _____

City Clerk

EXAMINED AND APPROVED:

Donald B. Just
Corporation Counsel

PARTY OF THE SECOND PART

R.A. CULLINAN & SON
A DIVISION OF UNITED CONTRACTORS MIDWEST, INC
(name of individual, firm or corporation)

BY: _____

(member of firm or officer of corporation)

(If a Co-Partnership)

_____ (seal)

_____ (seal)

Partners doing business under the firm name
of _____ (seal)

(PARTY OF THE SECOND PART)

(If an Individual)

_____ (seal)

(PARTY OF THE SECOND PART)

CITY OF PEORIA
PERFORMANCE BOND

Bond #106542893

KNOW ALL MEN BY THESE PRESENTS, That I/we R.A. CULLINAN & SON, INC., A DIV. OF UNITED CONTRACTORS MIDWEST, INC.

an individual, of _____

a co-partnership, of _____

a corporation organized under the laws of the State of Delaware

as Principal, and Travelers Casualty & Surety Company of America

a corporation organized and existing under the laws of the State of Connecticut with authority to do business in the State of Illinois, as Surety, are held and firmly bound unto the City of

Peoria, Peoria County, State of Illinois, in the penal sum of FOUR HUNDRED THIRTY-FOUR THOUSAND SEVEN HUNDRED THIRTY-ONE & 28/100 Dollars (\$434,731.28) lawful money of the United States, well and truly to be paid unto said City of Peoria for the payment of which we bind ourselves, our heirs, executors, administrators, successors, and assigns, jointly, severally, and firmly by these presents.

THE CONDITION OF THE FOREGOING OBLIGATIONS IS SUCH that whereas, the said Principal has entered into a contract with the City of Peoria for COLUMBINE DRIVE RECONSTRUCTION - NORTHTRAIL DRIVE TO HICKORY GROVE ROAD in accordance with the terms and conditions of said contract, which is hereby referred to and made a part hereof as if fully set forth herein;

NOW, THEREFOR, the condition of this obligation is such, that if the above bounden Principal shall well and truly keep, do and perform, each and every, all and singular, the matters and things in said contract set forth and specified to be by said Principal kept, done and performed, at the times and in the manner in said contract specified, or shall pay over, make good and reimburse the City of Peoria, all loss and damage which it may sustain by reason of the failure or default on the part of the Principal so to do, then this obligation shall be null and void; otherwise to remain in full force and effect.

IN WITNESS WHEREOF, we have duly executed the foregoing Obligation this 23rd day of June, 2016.

FOR THE CITY OF PEORIA

EXAMINED AND APPROVED:

Donald B. Teit
Corporation Counsel

Principal
Travelers Casualty & Surety Company of America

Sureties
Patrick J. Taphorn, Attorney-in-Fact

STATE OF Illinois)
) SS
COUNTY OF Tazewell)

I, Amy E. Ries, a Notary Public in and for said County, in the State aforesaid, do hereby certify that Patrick J. Taphorn, who is personally known to me to be the same person who signed the above foregoing instrument as the Attorney in Fact for Travelers Casualty & Surety Company of America, appeared before me this day in person and acknowledged that he signed the name of Patrick J. Taphorn, thereto, as his Principal, and his own name as Attorney in Fact, as the free and voluntary act of his said Principal for the uses and purposes therein set forth, and that he executed the said instrument under authority given him by his said Principal.

Given under my hand and Notarial Seal, this 23rd day of June, 2016.



Amy E. Ries
Notary Public



POWER OF ATTORNEY

Farmington Casualty Company
Fidelity and Guaranty Insurance Company
Fidelity and Guaranty Insurance Underwriters, Inc.
St. Paul Fire and Marine Insurance Company
St. Paul Guardian Insurance Company

St. Paul Mercury Insurance Company
Travelers Casualty and Surety Company
Travelers Casualty and Surety Company of America
United States Fidelity and Guaranty Company

Attorney-In Fact No. 226368

Certificate No. 006345499

KNOW ALL MEN BY THESE PRESENTS: That Farmington Casualty Company, St. Paul Fire and Marine Insurance Company, St. Paul Guardian Insurance Company, St. Paul Mercury Insurance Company, Travelers Casualty and Surety Company, Travelers Casualty and Surety Company of America, and United States Fidelity and Guaranty Company are corporations duly organized under the laws of the State of Connecticut, that Fidelity and Guaranty Insurance Company is a corporation duly organized under the laws of the State of Iowa, and that Fidelity and Guaranty Insurance Underwriters, Inc., is a corporation duly organized under the laws of the State of Wisconsin (herein collectively called the "Companies"), and that the Companies do hereby make, constitute and appoint

Afton Booth, Patrick J. Taphorn, and Kathy Betteridge

of the City of Pekin, State of Illinois, their true and lawful Attorney(s)-in-Fact, each in their separate capacity if more than one is named above, to sign, execute, seal and acknowledge any and all bonds, recognizances, conditional undertakings and other writings obligatory in the nature thereof on behalf of the Companies in their business of guaranteeing the fidelity of persons, guaranteeing the performance of contracts and executing or guaranteeing bonds and undertakings required or permitted in any actions or proceedings allowed by law.

IN WITNESS WHEREOF, the Companies have caused this instrument to be signed and their corporate seals to be hereto affixed, this 12th day of May, 2015.

Farmington Casualty Company
Fidelity and Guaranty Insurance Company
Fidelity and Guaranty Insurance Underwriters, Inc.
St. Paul Fire and Marine Insurance Company
St. Paul Guardian Insurance Company

St. Paul Mercury Insurance Company
Travelers Casualty and Surety Company
Travelers Casualty and Surety Company of America
United States Fidelity and Guaranty Company



State of Connecticut
City of Hartford ss.

By: [Signature]
Robert L. Raney, Senior Vice President

On this the 12th day of May, 2015, before me personally appeared Robert L. Raney, who acknowledged himself to be the Senior Vice President of Farmington Casualty Company, Fidelity and Guaranty Insurance Company, Fidelity and Guaranty Insurance Underwriters, Inc., St. Paul Fire and Marine Insurance Company, St. Paul Guardian Insurance Company, St. Paul Mercury Insurance Company, Travelers Casualty and Surety Company, Travelers Casualty and Surety Company of America, and United States Fidelity and Guaranty Company, and that he, as such, being authorized so to do, executed the foregoing instrument for the purposes therein contained by signing on behalf of the corporations by himself as a duly authorized officer.

In Witness Whereof, I hereunto set my hand and official seal.
My Commission expires the 30th day of June, 2016.



[Signature]
Marie C. Tetreault, Notary Public

This Power of Attorney is granted under and by the authority of the following resolutions adopted by the Boards of Directors of Farmington Casualty Company, Fidelity and Guaranty Insurance Company, Fidelity and Guaranty Insurance Underwriters, Inc., St. Paul Fire and Marine Insurance Company, St. Paul Guardian Insurance Company, St. Paul Mercury Insurance Company, Travelers Casualty and Surety Company, Travelers Casualty and Surety Company of America, and United States Fidelity and Guaranty Company, which resolutions are now in full force and effect, reading as follows:

RESOLVED, that the Chairman, the President, any Vice Chairman, any Executive Vice President, any Senior Vice President, any Vice President, any Second Vice President, the Treasurer, any Assistant Treasurer, the Corporate Secretary or any Assistant Secretary may appoint Attorneys-in-Fact and Agents to act for and on behalf of the Company and may give such appointee such authority as his or her certificate of authority may prescribe to sign with the Company's name and seal with the Company's seal bonds, recognizances, contracts of indemnity, and other writings obligatory in the nature of a bond, recognizance, or conditional undertaking, and any of said officers or the Board of Directors at any time may remove any such appointee and revoke the power given him or her; and it is

FURTHER RESOLVED, that the Chairman, the President, any Vice Chairman, any Executive Vice President, any Senior Vice President or any Vice President may delegate all or any part of the foregoing authority to one or more officers or employees of this Company, provided that each such delegation is in writing and a copy thereof is filed in the office of the Secretary; and it is

FURTHER RESOLVED, that any bond, recognizance, contract of indemnity, or writing obligatory in the nature of a bond, recognizance, or conditional undertaking shall be valid and binding upon the Company when (a) signed by the President, any Vice Chairman, any Executive Vice President, any Senior Vice President or any Vice President, any Second Vice President, the Treasurer, any Assistant Treasurer, the Corporate Secretary or any Assistant Secretary and duly attested and sealed with the Company's seal by a Secretary or Assistant Secretary; or (b) duly executed (under seal, if required) by one or more Attorneys-in-Fact and Agents pursuant to the power prescribed in his or her certificate or their certificates of authority or by one or more Company officers pursuant to a written delegation of authority; and it is

FURTHER RESOLVED, that the signature of each of the following officers: President, any Executive Vice President, any Senior Vice President, any Vice President, any Assistant Vice President, any Secretary, any Assistant Secretary, and the seal of the Company may be affixed by facsimile to any Power of Attorney or to any certificate relating thereto appointing Resident Vice Presidents, Resident Assistant Secretaries or Attorneys-in-Fact for purposes only of executing and attesting bonds and undertakings and other writings obligatory in the nature thereof, and any such Power of Attorney or certificate bearing such facsimile signature or facsimile seal shall be valid and binding upon the Company and any such power so executed and certified by such facsimile signature and facsimile seal shall be valid and binding on the Company in the future with respect to any bond or understanding to which it is attached.

I, Kevin E. Hughes, the undersigned, Assistant Secretary, of Farmington Casualty Company, Fidelity and Guaranty Insurance Company, Fidelity and Guaranty Insurance Underwriters, Inc., St. Paul Fire and Marine Insurance Company, St. Paul Guardian Insurance Company, St. Paul Mercury Insurance Company, Travelers Casualty and Surety Company, Travelers Casualty and Surety Company of America, and United States Fidelity and Guaranty Company do hereby certify that the above and foregoing is a true and correct copy of the Power of Attorney executed by said Companies, which is in full force and effect and has not been revoked.

IN TESTIMONY WHEREOF, I have hereunto set my hand and affixed the seals of said Companies this 23rd day of June, 20 16.

WARNING: THIS POWER OF ATTORNEY IS INVALID WITHOUT THE RED BORDER

Kevin E. Hughes
Kevin E. Hughes, Assistant Secretary



To verify the authenticity of this Power of Attorney, call 1-800-421-3880 or contact us at www.travelersbond.com. Please refer to the Attorney-In-Fact number, the above-named individuals and the details of the bond to which the power is attached.

TABLE OF CONTENTS

<u>ITEM</u>	<u>PAGE</u>
PROPOSAL ITEMS	
NOTICE TO CONTRACTORS	4
PROPOSAL	5
SCHEDULE OF PRICES	8
SIGNATURE PAGE	11
BID BOND	12
SUB-CONTRACTOR UTILIZATION STATEMENT	13
M/WBE PARTICIPATION WAIVER REQUEST	15
 GENERAL CONDITIONS	
DESCRIPTION OF WORK	17
ADDITIONAL WORK, CONTRACTOR RESPONSIBILITIES	17
DEFINITION OF TERMS	17
FAILURE TO COMPLETE WORK ON TIME	18
RESPONSIBILITY FOR DAMAGE CLAIMS	18
QUALIFICATION OF CONTRACTORS	19
CONTRACTOR'S INSURANCE	19
PROOF OF CARRIAGE OF INSURANCE	20
GUARANTEE PERIOD	21
PROSECUTION AND PROGRESS OF WORK	21
EXISTING UNDERGROUND FACILITIES	21
COOPERATION WITH UTILITY COMPANIES	21
NOTIFICATION OF UTILITIES PRIOR TO CONSTRUCTION	22
J.U.L.I.E. SYSTEM	22
CERTIFIED PAYROLL REQUIREMENTS	22
PREVAILING WAGE PROVISION	22
SUBSTANCE ABUSE PREVENTION PROGRAM	28
PROTECTION OF THE PUBLIC	29
ITEMS DESIGNATED OR REMOVAL AND EXCAVATION	29
CITY SIGNS	29
DAMAGE TO EXISTING TREES	29
SAWCUTTING	29
CONTACT PERSON	29
 EQUAL OPPORTUNITY REQUIREMENTS	
EEO CONTRACT COMPLIANCE CLAUSE	30
REQUIREMENTS FOR GOOD FAITH EFFORTS	33
HUMAN RIGHTS ACT	40
 ROADWORK SPECIAL PROVISIONS	
SALVAGING EXISTING MATERIAL	42
CONSTRUCTION DEBRIS	42
EROSION CONTROL	42
TRENCH BACKFILL	43

ITEM	PAGE
INLETS TYPE G-1 (SPECIAL).....	43
TRAFFIC CONTROL AND PROTECTION.....	43
BEAVER DAMS.....	44
INLET MANHOLES, TYPE G-1, 4' DIA., (SPECIAL).....	44
INLET-MANHOLE, TYPE G-1, 4' DIA. (SPECIAL).....	44
AGGREGATE BASE COURSE, CS-01.....	45
AGGREGATE BASE COURSE, CA-6.....	45
TEMPORARY MAILBOX RELOCATION.....	45
UNDERCUTTING SUBABSE.....	45
GEOTECHNICAL FABRIC FOR GROUND STABILIZATION.....	46
P.C.C. DRIVEWAY PAVEMENT, 6".....	46
P.C.C. SIDEWALK, 4".....	46
TREE REMOVAL & RELOCATION.....	44
DETECTABLE WARNINGS.....	47
DRIVEWAY PAVEMENT REMOVAL, PAVEMENT REMOVAL.....	48
CURING COMPOUND.....	48
CONCRETE FIBERS.....	49
SEEDING & MULCHING.....	49
SIDEWALK RAMPS FOR THE DISABLED.....	49
TIE BARS & DOWEL BARS.....	49
RECTANGULAR RAPID FLASHING BEACON WITH TYPE A CONC. BASE.....	49

APPENDIX A

EEO DOCUMENTS

EMPLOYER REPORT CC-1.....	52
MINORITY AND WOMEN BUSINESS ENTERPRISE DIRECTORY.....	53
EQUAL EMPLOYMENT OPPORTUNITY.....	53
MINORITY AND FEMALE WORKFORCE UTILIZATION.....	53

CONTRACT DELIVERABLES

SUBCONTRACTOR PAYMENT FORM.....	55
MONTHLY WORKFORCE ANALYSIS.....	56
NOTIFICATION OF CHANGE IN PARTICIPATION.....	57

MISCELLANEOUS

SAMPLE CONTRACT.....	59
----------------------	----

PROPOSAL ITEMS

STATE OF ILLINOIS
CITY OF PEORIA

NOTICE TO CONTRACTORS

1. Time and Place of Opening Bids.

Sealed proposals for the improvement described herein will be received at the Office of the City Engineer, Public Works Facility, 3505 N. Dries Lane, Peoria, Illinois, until **11:00 A.M., Thursday, June 16, 2016** and at that time publicly opened and read.

2. Description of Work.

(A) Proposed improvement is officially known as, **COLUMBINE DRIVE RECONSTRUCTION – NORTHTRAIL DRIVE TO HICKORY GROVE ROAD.**

(B) The proposed improvement consists of removing existing pavement, sidewalk, curb, curb and gutter, driveways, and driveway approaches and replacing with new roadway, sidewalk, curb, driveway, driveway approaches, curb and gutter, ADA Ramps and all necessary adjustments, incidentals and appurtenances. An alternate bid will be taken on a PCC Base.

3. Instructions to Bidders.

(A) Plans, proposal forms, and specifications for said proposed project may be examined at the Offices of the City Engineer, Public Works Facility, 3505 North Dries Lane, Peoria, IL. Before plans and specifications may be obtained, contractors must be pre-qualified. Complete sets of plans and proposal forms may be obtained on CD at no charge; contact information must be given in exchange for the CD. Each business may receive one CD at no-cost, or request an electronic plan set by email to pwdropbox@peoriagov.org.

(B) All proposals must be accompanied by a proposal guaranty as provided in Section 102 of the “Standard Specifications for Road and Bridge Construction” prepared by the Illinois Department of Transportation: a Bid Bond, or a proposal guarantee of cash, a Bank Cashier Check, or a properly certified check made payable to the City of Peoria, for not less than five percent (5%) of the amount of the bid.

4. Rejection of Bids.

The City of Peoria reserves the right to reject any or all proposals as provided in LRS6 of the “Supplemental Specifications and Recurring Special Provisions” prepared by the Department of Transportation of the State of Illinois, adopted January 1, 2016.

STATE OF ILLINOIS
CITY OF PEORIA

PROPOSAL

1. Proposal of R.A. Cullinan & Son, a Div. of UCM, Inc., Tremont, IL
i. (Name and Address of Bidder)
For the improvement, designated in Paragraph 2 below, for the construction of roadway, sidewalk, combination curb and sidewalk, combination curb and gutter, curb, gutter flag, driveway pavement, ADA access ramps.
2. The contract documents for the proposed improvements are those prepared by Mohr & Kerr Engineering & Land surveying, P.C. and the City of Peoria Engineering Department and approved in May 2016 which contract documents are designated as "COLUMBINE DRIVE RECONSTRUCTION – NORTHTRAIL DRIVE TO HICKORY GROVE ROAD".
3. The specifications herein referred to are the "Standard Specifications for Road and Bridge Construction," prepared by the Department of Transportation of the State of Illinois and adopted by said Department on April 1, 2016. The undersigned agrees to accept, as part of the contract, the Special Provisions contained within this proposal.
4. The undersigned declares that he will comply with the applicable provisions of Section 100, General Requirements and Covenants.
5. The undersigned agrees to complete the work, by September 23, 2016 unless additional time is granted in accordance with Article 108.08 of the Specifications.
6. Accompanying this proposal is a bid bond, certified check, or cashier's check complying with the requirements of the Specifications, made payable to the City Treasurer of the City of Peoria, Illinois. If this proposal is accepted and the undersigned fails to execute a contract and contract bond as required, it is hereby agreed that the check shall be forfeited to the awarding authority.

The amount of the check or draft is \$ (a bid bond).

Attach Cashier's Check or Certified Check Here

7. The undersigned certifies that it is not delinquent in the payment of any indebtedness, tax, fee or fine owed to the City of Peoria, or in the payment of any tax administered by the Illinois Department of Revenue, and is in compliance with the terms and conditions of Sec. 10-109 of the Peoria City Code and 65 ILCS 5/11-42.1-1.
8. Each pay item shall have a unit price and a total price.
9. The unit price shall govern if no total price is shown or if there is a discrepancy between the product of the unit price multiplied by the quantity.
10. If a unit price is omitted, the total price will be divided by the quantity in order to establish a unit price.
11. A bid will be declared unacceptable if neither a unit price nor a total price is shown.
12. The undersigned firm certifies that it has not been convicted of bribery or attempting to bribe an officer or employee of the City of Peoria, nor has the firm made an admission of guilt of such conduct which is a matter of record, nor has an official, agent, or employee of the firm committed bribery or attempted bribery on behalf of the firm and pursuant to the direction or authorization of a responsible official of the firm. The undersigned firm further certifies that it is not barred from contracting with any unit of Federal, State or local government as a result of a violation of State laws prohibiting bid-rigging or bid-rotating and has not been suspended or debarred from receiving federal funding.
13. EMPLOYEE/EMPLOYMENT RESTRICTIONS – THE CONTRACTOR:

THE CONTRACTOR, (hereinafter referred to as “SERVICE PROVIDER”) agrees, as a condition of accepting this contract with the City of Peoria, that, for a period of one (1) year following completion of this contract, it shall be prohibited from hiring, directly or indirectly, any City employee or official who was involved, directly or indirectly in: (1) the selection and/or recommendation to select the SERVICE PROVIDER for performance of this contract; (2) coordinating the efforts of the SERVICE PROVIDER in the consummation or completion of this contract; or (3) monitoring or determining the performance of the SERVICE PROVIDER. The SERVICE PROVIDER further acknowledges and agrees that, upon the City’s determination that a violation of this provision has occurred, the penalty imposed, at the sole discretion of the City, may include one or more of the following: (1) cancellation of any other contract(s) between the City of Peoria and the SERVICE PROVIDER; (2) disqualification of the SERVICE PROVIDER from bidding or being awarded future contracts with the City of Peoria for a period of two [2] years; and/or (3) payment of liquidated damages to the City of Peoria in the amount of TWENTY FIVE THOUSAND DOLLARS (\$25,000.00).

This does not apply to any City Employee involved in the 2011-12 reduction in force; nor does it apply to parties taking the Early Retirement incentive offered by the City from November 1, 2011 through November 1, 2012.

14. EEO CERTIFICATION* (Check one):

We are presently applying for the EEO Certification. Employer Report Form (Form CC-1) is completed and enclosed.

Presently, we have the Employer Report Form (Form CC-1) on file with the City of Peoria, Office of Equal Opportunity and have a current Certificate of Compliance Number.

Certificate of Compliance Number: 00676-170331

**Please note there is a \$50.00 processing fee for new and renewal certification requests.*

15. The City of Peoria can increase or decrease this contract up to 25% to meet its budgetary needs.

16. The undersigned submits herewith this Schedules of Prices covering the work to be performed under this contract:



a division of United Contractors Midwest, Inc.

121 West Park St. - P.O. Box 166
Tremont, Illinois 61568

CONCRETE GRAVEL & BITUMINOUS PAVEMENTS
CONCRETE AND STEEL BRIDGES AND CULVERTS
PILE DRIVING - EXCAVATING - DRAINAGE DITCHES

OFFICE PHONE 925-2711
Area Code 309 PEORIA 676-4343
Area Code 309 PEKIN 346-7262
FAX 309-925-7131

Quote To: City of Peoria, IL

Job Name: Columbine Drive

Project Location: Peoria, IL

Date of Plans: 06/01/2016

Bid Date: June 16, 2016

FSA: 0616COLPEO

Addendum: *1 Addendum #2 Act*

Attn:
Phone:
Mobile:
Fax:

ITEM	DESCRIPTION	QUANTITY	UNIT	UNIT PRICE	AMOUNT
COLUMBINE DRIVE: BASE BID					
20200100	EARTH EXCAVATION	1,219.00	CY	35.83	43,676.77
20400800	FURNISHED EXCAVATION	421.00	CY	0.01	4.21
21101615	TOPPSOIL F&P, 4"	709.00	SY	8.10	5,742.90
25200100	SODDING	709.00	SY	11.88	8,422.92
20101400	NITROGEN FERT NUTRIENT	9.00	LB	6.48	58.32
20101500	PHOSPH FERT NUTRIENT	9.00	LB	6.48	58.32
20101600	POTASS FERT NUTRIENT	9.00	LB	6.48	58.32
21001000	GEO FABRIC FOR GR. STABILIZATION	2,959.00	SY	1.00	2,959.00
28000500	INLET & PIPE PROTECTION	5.00	EA	114.21	571.05
40600275	BIT MATERIALS (PRIME COAT)	6,658.00	LB	0.82	5,459.56
40600290	BIT MATERIALS (TACK COAT)	8,877.00	LB	0.41	3,639.57
40603080	HMA BINDER CRSE, IL-19.0,N50, 2 1/2"	414.00	TON	90.36	37,409.04
40603335	HMA SURFACE CRSE, MIXTURE D, N50, 2"	331.00	TON	104.39	34,553.09
40300200	PCC DRIVEWAY PVT, 6"	488.00	SY	67.05	32,720.40
42400800	DETECTABLE WARNINGS	52.00	SF	25.61	1,331.72
42400100	PCC SIDEWALK, 4"	913.00	SF	6.31	5,761.03
44000100	PVT REMOVAL	3,582.00	SY	10.99	39,366.18
44000200	DRIVEWAY PVT REMOVAL	252.00	SY	9.58	2,414.16
44000500	COMBINATION CURB & GUTTER REM.	2,104.00	FOOT	6.78	14,265.12
44000600	SIDEWALK REMOVAL	231.00	SF	2.17	501.27
550A0340	STR SEWER, CL A, TY 2, RCP, 12"	11.00	FOOT	101.02	1,111.22
550A0410	STR SEWER, CL A, TY 2, RCP, 24"	30.00	FOOT	105.94	3,178.20
55100500	STR SEWER REM, 12"	23.00	FOOT	33.30	765.90
55101200	STR SEWER REM, 24"	41.00	FOOT	37.36	1,531.76
60500040	REMOVING MANHOLES	2.00	EA	767.16	1,534.32
60500060	REMOVING INLETS	3.00	EA	255.72	767.16
60604400	COM CURB & GUTTER, TY B-6.18	2,117.00	FOOT	25.01	52,946.17

ITEM	DESCRIPTION	QUANTITY	UNIT	UNIT PRICE	AMOUNT
X0327301	RELOCATE EX MAILBOX	26.00	EA	268.89	6,991.14
	TRENCH BACKFILL	133.00	TON	25.97	3,454.01
	BEAVER DAMS	7.00	EA	183.17	1,282.19
	UNDER CUTTING SUBBASE	148.00	CY	27.93	4,133.64
	GEO TECH FABRIC FOR BSE REPAIR (SPL)	296.00	SY	2.33	689.68
	INLET, TY G-1 (SPL)	2.00	EA	3,688.58	7,377.16
	INLET MH, TY G-1 (SPL)	1.00	EA	7,150.00	7,150.00
	INLET MH, TY G-1, 4' DIA. (SPL)	2.00	EA	4,189.86	8,379.72
	AGG BSE CRSE, CA-6	1,055.00	TON	28.12	29,666.60
	AGG BSE CRSE, TY B, CS-01, 7"	1,179.00	TON	25.22	29,734.38
	RECT.RAPID FL BEACON W. TY A CONC BSE	1.00	PAIR	11,394.00	11,394.00
	TREE REM AND RELOCATION	2.00	EA	351.00	702.00
	TEMP MAILBOX RELOCATION	1.00	LS	2,392.77	2,392.77
	TRAFFIC CONTROL AND PROTECTION	1.00	LS	14,407.01	14,407.01
	CONSTRUCTION STAKING	1.00	LS	6,169.30	6,169.30
	TOTAL: BASE BID				\$434,731.28
	COLUMBINE DRIVE: ALTERNATE BID				<i>Appendix #1 Ack</i>
20200100	EARTH EXCAVATION	913.00	CY	36.90	33,689.70
20400800	FURNISHED EXCAVATION	421.00	CY	0.01	4.21
21101615	TOPSOIL F & P, 4"	709.00	SY	9.20	6,522.80
25200100	SODDING	709.00	SY	11.88	8,422.92
20101400	NITROGEN FERT NUTRIENT	9.00	LB	6.48	58.32
20101500	PHOSPH FERT NUTRIENT	9.00	LB	6.48	58.32
20101600	POTASS FERT NUTRIENT	9.00	LB	6.48	58.32
21001000	GEO TECH FABRIC FOR GR STABILIZATION	2,959.00	SY	1.00	2,959.00
28000500	INLET & PIPE PROTECTION	5.00	EA	114.21	571.05
40600290	BIT MAT'L (TACK COAT)	8,877.00	LB	0.41	3,639.57
40603335	HMA SURFACE CRSE, MIX D, N50, 1 1/2"	249.00	TON	115.56	28,774.44
42300200	PCC DRIVEWAY PVT, 6"	488.00	SY	67.05	32,720.40
42400800	DETECTABLE WARNINGS	52.00	SF	25.61	1,331.72
42400100	PCC SIDEWALK, 4"	913.00	SF	6.31	5,761.03
44000100	PVT REMOVAL	3,582.00	SY	10.99	39,366.18
44000200	DRIVEWAY PVT REMOVAL	252.00	SY	9.58	2,414.16
44000500	COMB CURB & GUTTER REMOVAL	2,104.00	FOOT	6.78	14,265.12
44000600	SIDEWALK REMOVAL	231.00	SF	2.17	501.27
550A0340	STR SEWER, CL A, TY 2,RCP,12"	11.00	FOOT	101.02	1,111.22
550A0410	STR SEWER, CL A, TY 2,RCP,24"	30.00	FOOT	105.94	3,178.20
55100500	STR SEWER REMOVAL 12"	23.00	FOOT	33.30	765.90
55101200	STR SEWER REMOVAL, 24"	41.00	FOOT	37.36	1,531.76
60500040	REMOVING MANHOLES	2.00	EA	767.16	1,534.32
60500060	REMOVING INLETS	3.00	EA	255.72	767.16
60604400	COMB CURB & GUTTER, TY B-6.18	2,117.00	FOOT	27.70	58,640.90
X0327301	RELOCATE EX MAILBOX	26.00	EA	268.89	6,991.14
	PCC BSE CRSE, 5"	2,959.00	SY	36.01	106,553.59
	TRENCH BACKFILL	133.00	TON	25.97	3,454.01

ITEM	DESCRIPTION	QUANTITY	UNIT	UNIT PRICE	AMOUNT
	BEAVER DAMS	7.00	EA	183.17	1,282.19
	UNDERCUTTING SUBBASE	148.00	CY	27.93	4,133.64
	GEO FABRIC FOR BASE REPAIRS ((SPL)	296.00	SY	2.33	689.68
	INLET, TY G-1 (SPECIAL)	2.00	EA	3,688.58	7,377.16
	INLET MANHOLE, TY G-1 ,(SPL)	1.00	EA	7,150.00	7,150.00
	INLET MANHOLE, TY G-1, 4 DIA (SPL)	2.00	EA	4,189.86	8,379.72
	AGG BSE CRSE, CA-6	1,223.00	TON	27.61	33,767.03
	RECT RAPID FL BEACON W TY A CON BSE	1.00	PAIR	11,394.00	11,394.00
	TREE REMOVAL AND RELOCATE	2.00	EA	351.00	702.00
	TEMPORARY MAILBOX RELOCATION	1.00	LS	2,392.77	2,392.77
	TRAFFIC CONTROL & PROTECTION	1.00	LS	16,495.83	16,495.83
	CONSTRUCTION STAKING	1.00	LS	5,936.61	5,936.61
	TOTAL: ALTERNATE BID				\$465,347.36

NOTES:

Addendum # 2 McK

Thank you for the opportunity to bid on this project. We look forward to working with you.

Tom Wall
R. A. Cullinan & Son
a division of United Contractors Midwest, Inc.

Signed Thomas D. Wall

Signed _____

Date 6/16/14

Date _____

COLUMBINE SCHEDULE OF PRICES - BASE BID

CODE NO.	ITEM	UNIT	QUANTITY	UNIT COST	TOTAL
20200100	EARTH EXCAVATION	CU YD	1219		
20400800	FURNISHED EXCAVATION	CU YD	421		
21101615	TOPSOIL FURNISH AND PLACE, 4"	SQ YD	709		
25200100	SODDING	SQ YD	709		
20101400	NITROGEN FERTILIZER NUTRIENT	POUND	9		
20101500	PHOSPHORUS FERTILIZER NUTRIENT	POUND	9		
20101600	POTASSIUM FERTILIZER NUTRIENT	POUND	9		
21001000	GEOTECHNICAL FABRIC FOR GROUND STABILIZATION	SQ YD	2,959		
28000500	INLET AND PIPE PROTECTION	EACH	5		
40600275	BITUMINOUS MATERIALS (PRIME COAT)	POUND	6,658		
40600290	BITUMINOUS MATERIALS (TACK COAT)	POUND	8,877		
40603080	HOT-MIX ASPHALT BINDER COURSE, IL-19.0, N50, 2 1/2"	TON	414		
40603335	HOT-MIX ASPHALT SURFACE COURSE, MIXTURE "D", N50, 2"	TON	331		
42300200	PCC DRIVEWAY PAVEMENT, 6"	SQ YD	488		
42400800	DETECTABLE WARNINGS	SQ FT	52		
42400100	PORTLAND CEMENT CONCRETE SIDEWALK, 4"	SQ FT	913		
44000100	PAVEMENT REMOVAL	SQ YD	3,582		
44000200	DRIVEWAY PAVEMENT REMOVAL	SQ YD	252		
44000500	COMBINATION CURB AND GUTTER REMOVAL	FOOT	2,104		
44000600	SIDEWALK REMOVAL	SQ FT	231		
550A0340	STORM SEWER, CL. A, TYPE 2, RCP, 12"	FOOT	11		
550A0410	STORM SEWER, CL. A, TYPE 2, RCP, 24"	FOOT	30		
55100500	STORM SEWER REMOVAL, 12"	FOOT	23		
55101200	STORM SEWER REMOVAL, 24"	FOOT	41		
60500040	REMOVING MANHOLES	EACH	2		
60500060	REMOVING INLETS	EACH	3		
60604400	COMBINATION CONCRETE CURB AND GUTTER, TYPE B-6.18	FOOT	2,117		
X0327301	RELOCATE EXISTING MAILBOX	EACH	26		
	TRENCH BACKFILL	TON	133		
	BEAVER DAMS	EACH	7		
	UNDERCUTTING SUBBASE	CY	148		
	GEOTECHNICAL FABRIC FOR BASE REPAIRS (SPECIAL)	SQ YD	296		
	INLET, TYPE G-1 (SPECIAL)	EACH	2		
	INLET MANHOLE, TYPE G-1 (SPECIAL)	EACH	1		
	INLET-MANHOLE, TYPE G-1, 4' DIA. (SPECIAL)	EACH	2		
	AGGREGATE BASE COURSE, CA-6	TON	1,055		
	AGGREGATE BASE COURSE, TYPE B, CS-01, 7"	TON	1,179		

	RECT.RAPID FLASHING BEACON WITH TYPE A CONC. BASE	PAIR	1		
	TREE REMOVAL AND RELOCATION	EACH	2		
	TEMPORARY MAILBOX RELOCATION	L SUM	1		
	TRAFFIC CONTROL AND PROTECTION	L SUM	1		
	CONSTRUCTION STAKING	L SUM	1		
TOTAL - BASE BID					

COLUMBINE SCHEDULE OF PRICES - ALTERNATE BID

CODE NO.	ITEM	UNIT	QUANTITY	UNIT COST	TOTAL
20200100	EARTH EXCAVATION	CU YD	913		
20400800	FURNISHED EXCAVATION	CU YD	421		
21101615	TOPSOIL FURNISH AND PLACE, 4"	SQ YD	709		
25200100	SODDING	SQ YD	709		
20101400	NITROGEN FERTILIZER NUTRIENT	POUND	9		
20101500	PHOSPHORUS FERTILIZER NUTRIENT	POUND	9		
20101600	POTASSIUM FERTILIZER NUTRIENT	POUND	9		
21001000	GEOTECHNICAL FABRIC FOR GROUND STABILIZATION	SQ YD	2,959		
28000500	INLET AND PIPE PROTECTION	EACH	5		
40600290	BITUMINOUS MATERIALS (TACK COAT)	POUND	8,877		
40603335	HOT-MIX ASPHALT SURFACE COURSE, MIXTURE "D", N50, 1 1/2"	TON	249		
42300200	PCC DRIVEWAY PAVEMENT, 6"	SQ YD	488		
42400800	DETECTABLE WARNINGS	SQ FT	52		
42400100	PORTLAND CEMENT CONCRETE SIDEWALK, 4"	SQ FT	913		
44000100	PAVEMENT REMOVAL	SQ YD	3,582		
44000200	DRIVEWAY PAVEMENT REMOVAL	SQ YD	252		
44000500	COMBINATION CURB AND GUTTER REMOVAL	FOOT	2,104		
44000600	SIDEWALK REMOVAL	SQ FT	231		
550A0340	STORM SEWER, CL. A, TYPE 2, RCP, 12"	FOOT	11		
550A0410	STORM SEWER, CL. A, TYPE 2, RCP, 24"	FOOT	30		
55100500	STORM SEWER REMOVAL, 12"	FOOT	23		
55101200	STORM SEWER REMOVAL, 24"	FOOT	41		
60500040	REMOVING MANHOLES	EACH	2		
60500060	REMOVING INLETS	EACH	3		
60604400	COMBINATION CONCRETE CURB AND GUTTER, TYPE B-6.18	FOOT	2,117		
X0327301	RELOCATE EXISTING MAILBOX	EACH	26		
	P.C.C. BASE COURSE, 5"	SQ YD	2,959		
	TRENCH BACKFILL	TON	133		

BEAVER DAMS	EACH	7		
UNDERCUTTING SUBBASE	CY	148		
GEOTECHNICAL FABRIC FOR BASE REPAIRS (SPECIAL)	SQ YD	296		
INLET, TYPE G-1 (SPECIAL)	EACH	2		
INLET MANHOLE, TYPE G-1 (SPECIAL)	EACH	1		
INLET-MANHOLE, TYPE G-1, 4' DIA. (SPECIAL)	EACH	2		
AGGREGATE BASE COURSE, CA-6	TON	1,223		
RECTANGULAR RAPID FLASHING BEACON WITH TYPE A CONCRETE BASE	PAIR	1		
TREE REMOVAL AND RELOCATION	EACH	2		
TEMPORARY MAILBOX RELOCATION	L SUM	1		
TRAFFIC CONTROL AND PROTECTION	L SUM	1		
CONSTRUCTION STAKING	L SUM	1		
			TOTAL - ALTERNATE BID	

The undersigned further agrees that if awarded the contract for the sections contained in the following combinations, he will perform the work in accordance with the requirements of each individual proposal for the multiple bid specified in the schedule below.

(If an individual) Signature of Bidder _____

Business Address _____

(If a partnership) Firm Name _____

Signed by _____
President

Business Address _____

Insert Names _____
and Addresses _____
of all partners: _____

(If a corporation) Corporate Name R. A. Cullinan & Son, a Div. of United Contractors Midwest, Inc.

Signed by Thomas T. Wall
Thomas T. Wall, Vice President
Business Address P. O. Box 166
Tremont, IL 61568

Insert Names
of Officers:

Robert W. Bruner
President
Allen D. Cullinan
Secretary
Kenton W. Day
Treasurer

Attest: 
Assist. Secretary

Addendum #1 Acknowledged 



Local Agency
Proposal Bid Bond
 Columbine Dr Reconstruction
 Route Northtrail Dr to Hickory Grove
 County Peoria Road
 Local Agency City of Peoria
 Section _____

RETURN WITH BID

PAPER BID BOND

WE R.A. Cullinan & Son, A Division of United Contractors Midwest, Inc. as PRINCIPAL,
 and Travelers Casualty & Surety Company of America as SURETY,
 are held jointly, severally and firmly bound unto the above Local Agency (hereafter referred to as "LA") in the penal sum of 5% of the total bid price, or for the amount specified in the proposal documents in effect on the date of invitation for bids whichever is the lesser sum. We bind ourselves, our heirs, executors, administrators, successors, and assigns, jointly pay to the LA this sum under the conditions of this instrument.

WHEREAS THE CONDITION OF THE FOREGOING OBLIGATION IS SUCH that, the said PRINCIPAL is submitting a written proposal to the LA acting through its awarding authority for the construction of the work designated as the above section.

THEREFORE, if the proposal is accepted and a contract awarded to the PRINCIPAL by the LA for the above designated section and the PRINCIPAL shall within fifteen (15) days after award enter into a formal contract, furnish surety guaranteeing the faithful performance of the work, and furnish evidence of the required insurance coverage, all as provided in the "Standard Specifications for Road and Bridge Construction" and applicable Supplemental Specifications, then this obligation shall become void; otherwise it shall remain in full force and effect.

IN THE EVENT the LA determines the PRINCIPAL has failed to enter into a formal contract in compliance with any requirements as set forth in the preceding paragraph, then LA acting through its awarding authority shall immediately be entitled to recover the full penal sum set out above, together with all court costs, all attorney fees, and any other expense of recovery.

IN TESTIMONY WHEREOF, the said PRINCIPAL and the said SURETY have caused this instrument to be signed by their respective officers this 16th day of June, 2016.

PRINCIPAL

R.A. Cullinan & Son, A Division of United Contractors Midwest, Inc.
 (Company Name)
 By: Thomas T. Wall (Signature & Title)
 Thomas T. Wall, Vice President
 By: _____ (Signature & Title)

(IF PRINCIPAL is a joint venture of two or more contractors, the company names, and authorized signatures of each contract must be affixed.)

SURETY

Travelers Casualty & Surety Company Of America
 (Name of Surety)
 STATE OF ILLINOIS,
 COUNTY OF Tazewell
 By: Afton Booth (Signature of Attorney-in-Fact)
 Afton Booth, Attorney-in-Fact

I, Amy E. Ries, a Notary Public in and for said county,
 do hereby certify that Thomas T. Wall and Afton Booth
 (Insert names of individuals signing on behalf of PRINCIPAL and SURETY)

who are each personally known to me to be the same persons whose names are subscribed to the foregoing instrument on behalf of PRINCIPAL and SURETY, appeared before me this day in person and acknowledged respectively, that they signed and delivered said instruments as their free and voluntary act for the uses and purposes therein set forth.

Given under my hand and notarial seal this 16th day of June, 2016
 My commission expires 10-28-17
OFFICIAL SEAL
AMY E. RIES
 NOTARY PUBLIC - STATE OF ILLINOIS
 MY COMMISSION EXPIRES 10-28-2017
Amy E. Ries
 (Notary Public)

ELECTRONIC BID BOND

Electronic bid bond is allowed (box must be checked by LA if electronic bid bond is allowed)
 The Principal may submit an electronic bid bond, in lieu of completing the above section of the Proposal Bid Form. By providing an electronic bid bond ID code and by signing below, the Principal is ensuring the identified electronic bid bond has been executed and the Principal and Surety are firmly bound unto the LA under the conditions of the bid bond as shown above. (If PRINCIPAL is a joint venture of two or more contractors, an electronic bid bond ID code, company/Bidder name title and date must be affixed for each contractor in the venture.)

 Electronic Bid Bond ID Code

 (Company/Bidder Name)

 (Signature and Title)

 Date



POWER OF ATTORNEY

Farmington Casualty Company
Fidelity and Guaranty Insurance Company
Fidelity and Guaranty Insurance Underwriters, Inc.
St. Paul Fire and Marine Insurance Company
St. Paul Guardian Insurance Company

St. Paul Mercury Insurance Company
Travelers Casualty and Surety Company
Travelers Casualty and Surety Company of America
United States Fidelity and Guaranty Company

Attorney-In Fact No. 226368

Certificate No. 006345483

KNOW ALL MEN BY THESE PRESENTS: That Farmington Casualty Company, St. Paul Fire and Marine Insurance Company, St. Paul Guardian Insurance Company, St. Paul Mercury Insurance Company, Travelers Casualty and Surety Company, Travelers Casualty and Surety Company of America, and United States Fidelity and Guaranty Company are corporations duly organized under the laws of the State of Connecticut, that Fidelity and Guaranty Insurance Company is a corporation duly organized under the laws of the State of Iowa, and that Fidelity and Guaranty Insurance Underwriters, Inc., is a corporation duly organized under the laws of the State of Wisconsin (herein collectively called the "Companies"), and that the Companies do hereby make, constitute and appoint

Afton Booth, Patrick J. Taphorn, and Kathy Betteridge

of the City of Pekin, State of Illinois, their true and lawful Attorney(s)-in-Fact, each in their separate capacity if more than one is named above, to sign, execute, seal and acknowledge any and all bonds, recognizances, conditional undertakings and other writings obligatory in the nature thereof on behalf of the Companies in their business of guaranteeing the fidelity of persons, guaranteeing the performance of contracts and executing or guaranteeing bonds and undertakings required or permitted in any actions or proceedings allowed by law.

IN WITNESS WHEREOF, the Companies have caused this instrument to be signed and their corporate seals to be hereto affixed, this 12th day of May, 2015.

Farmington Casualty Company
Fidelity and Guaranty Insurance Company
Fidelity and Guaranty Insurance Underwriters, Inc.
St. Paul Fire and Marine Insurance Company
St. Paul Guardian Insurance Company

St. Paul Mercury Insurance Company
Travelers Casualty and Surety Company
Travelers Casualty and Surety Company of America
United States Fidelity and Guaranty Company



State of Connecticut
City of Hartford ss.

By: [Signature]
Robert L. Raney, Senior Vice President

On this the 12th day of May, 2015, before me personally appeared Robert L. Raney, who acknowledged himself to be the Senior Vice President of Farmington Casualty Company, Fidelity and Guaranty Insurance Company, Fidelity and Guaranty Insurance Underwriters, Inc., St. Paul Fire and Marine Insurance Company, St. Paul Guardian Insurance Company, St. Paul Mercury Insurance Company, Travelers Casualty and Surety Company, Travelers Casualty and Surety Company of America, and United States Fidelity and Guaranty Company, and that he, as such, being authorized so to do, executed the foregoing instrument for the purposes therein contained by signing on behalf of the corporations by himself as a duly authorized officer.

In Witness Whereof, I hereunto set my hand and official seal.
My Commission expires the 30th day of June, 2016.



[Signature]
Marie C. Tetreault, Notary Public



CITY OF PEORIA SUBCONTRACTOR UTILIZATION STATEMENT

Section I (select all that apply)

- MBE/WBE Subcontractor(s) will be utilized on this project
 Non MBE/WBE Subcontractor(s) will be utilized on this project

Section II

PRIME CONTRACTOR

Name: R. A. Cullinan & Son, a Div. of UCM, Inc.

Address: P.O. Box 166, Tremont, IL 61568

Phone: 309-925-2711

Contact Person: Kevin C. Walker

Email: kevin.walker@ucm.biz

Ownership Status: MBE WBE M/WBE Non-M/WBE

PROJECT

Columbine Drive Reconstruction

Name: Northtrail Dr. to Hickory Grove Rd.

Total Contract Value: \$434,731.20

Section III: Selected Subcontractors

Subcontractor Name	MBE, WBE or Non M/WBE	Amount	% of Total Contract	Scope of Work
Alexander Bros	MBE	35,650.00	8.2%	Trucking
Brew Bros Con Sawing	Non-MBE	315.00	0.1%	Put Sawing
CVL Landscaping	WBE	11,268.00	2.6%	Topsoil, Soil
Laser Electric	Non-MBE	10,550.00	2.4%	Electric
Midwest Constr. Serv	WBE	1,980.00	0.5%	Traffic Control
TOTALS		59,763.00	13.7%	

*If more than seven firms are utilized, please copy the form and attach the additional information.

Section IV: Subcontractors that submitted bids but were not selected (M/WBE Only)

Subcontractor Name	Scope of Work Bid	Denial Reason
Buddy's Ground Maint	Topsoil, Soil	not competitive

*If more than seven firms submitted quotes, please copy the form and attach the additional information.

For Office Use Only

Reviewed by: _____

Section V: Subcontractors Contacted (M/WBE Only)

Subcontractor Name	Method of Contact	Contact Outcome
Alexander Bros	Phone Call	used
Midwest Const. Serv	E-mail	used
Ordaz Construction	E-mail	no response
Central IL Consulting	E-mail	Not Competitive
CUL Landscaping	E-mail	used

**If more than seven firms were contacted, please copy the form and attach the additional information.*

Section VI

The City of Peoria is committed to promoting equal opportunity and has established the following subcontractor utilization goals for city funded construction projects: 10% MBE and 5% WBE. Prime Contractors have an obligation to make a good faith effort to advance the city's commitment to increase diversity among the firms working on city construction projects.

This form must be completed and submitted with bid proposals. ALL subcontractors intended for use on this project shall be listed in Section III above; along with the total amount to be paid to the subcontractors; percentage of total contract; and scope of work. If for whatever reason the prime contractor has to utilize a subcontractor not listed above, they must submit a Notification of Change in Participation.

The undersigned certifies that the information included herein is true and correct; the subcontractors listed above have agreed to perform the scope of work described. The undersigned further certifies that it has no controlling, dominating or conflict of interest in any of the listed subcontractors.

Thomas T. Wall

Signature of Prime Contractor
Thomas T. Wall, Vice President

June 16, 2016

Date

Org.: May 2008
Revised: Feb. 2011

For Office Use Only
Reviewed by: _____

**CITY OF PEORIA
M/WBE PARTICIPATION WAIVER REQUEST**

PRIME CONTRACTOR

R. A. Cullinan & Son,
Name: a Div. of UCM, Inc.
Address: P.O. Box 166, Tremont, IL 61568
Phone: 309-925-2711
Contact Person: Kevin C. Walker

PROJECT

Name: Columbine Drive Reconstruction
Northtrail Dr. to Hickory Grove Rd.

NA

We hereby request to waive all of the MBE and WBE participation goals on the above named project and self-perform all work for the following reason(s). The firm further affirms that the stated reasons and documents provided are true and correct and not misleading: **(CHECK ALL THAT APPLY. SPECIFIC SUPPORTING DOCUMENTATION MUST BE SUBMITTED WHERE INDICATED.)**

- 1. No MBEs/WBEs responded to our invitation to bid. _____
- 2. No subcontracting opportunities exist. (Attach explanation) _____
- 3. The award of subcontract(s) is impracticable. (Attach explanation) _____

SIGNED: *Thomas R. Wall*
(Company Official)

DATE: June 16, 2016

FOR OFFICE USE ONLY

APPROVED **DISAPPROVED**

REVIEWED BY _____ DATE _____



ADDENDUM NO. 1
CITY OF PEORIA

Columbine Road, Northtrail Drive to Hickory Grove Road
Date of Addendum: June 07, 2016
Letting: June 16, 2016 at 11:00 AM

RE: **Addendum No. 1** for Bid Package, Columbine Road Reconstruction, Northtrail Drive to Hickory Grove Road, Peoria, IL

The following shall be considered part of the Contract Documents for the subject project and shall apply to all construction there under:

REVISED BID DOCUMENT (Issued with this Addendum):

- 1) Page 48, Pavement Removal Specification: ADD the following sentence to the end of the first paragraph:
PAVEMENT REMOVAL shall also include milling the existing asphalt surface of areas per plan and returning all millings to the City of Peoria's storage facility on Darst Street.

Bidders shall acknowledge receipt of this addendum by inserting its number on Bid Form. Failure to do so may subject Bidder to Disqualification.

This Addendum consists of two (1) cover pages and one (1) Proposal and Specification book page.

Sincerely,

A handwritten signature in black ink, appearing to read "Stephen Letsky".

Stephen Letsky, P.E.

Final determination of acceptability shall be the responsibility of the construction engineer.

THESE FOUR METHODS ARE THE ONLY ACCEPTABLE MEANS FOR TRUNCATED DOME RAMPS WITHIN THE CITY OF PEORIA.

Detectable Warnings will be paid for at the contract unit price per square foot of surfacing, which shall include all labor, tools, materials and equipment necessary to complete the work as specified.

DRIVEWAY PAVEMENT REMOVAL, PAVEMENT REMOVAL

This work shall consist of the removal of all driveway pavement and other pavements as directed by the Engineer. This work shall be done in accordance with Section 440 of the "Standard Specifications for Road and Bridge Construction." Payment for removal and replacement will not be allowed for items removed beyond the limits of construction or those items damaged needlessly by the contractor. The cost of sawing pavement where noted or directed by the engineer shall be incidental to the item of work. PAVEMENT REMOVAL shall also include milling the existing asphalt of areas per plan and returning all millings to the City of Peoria's storage facility on Darst Street.

This work will be paid for at the contract unit price per SQUARE YARD for DRIVEWAY PAVEMENT REMOVAL and PAVEMENT REMOVAL; which shall include saw cutting, removing and disposing of said structure, all labor, tools, materials and equipment necessary to complete this work as specified.

COMBINATION CURB AND SIDEWALK REMOVAL, SIDEWALK REMOVAL

This work shall consist of the removal of all combination curb/sidewalk and sidewalk as directed by the Engineer. This work shall be done in accordance with Section 440 of the "Standard Specifications for Road and Bridge Construction." Payment for removal and replacement will not be allowed for items removed beyond the limits of construction or those items damaged needlessly by the contractor. The cost of sawing pavement where noted or directed by the engineer shall be incidental to the item of work.

The basis of payment shall be the area in square feet of the top surface of the curb and sidewalk for each property and will not include the front finished face of curb.

This work will be paid for at the contract unit price per SQUARE FOOT for SIDEWALK REMOVAL and COMBINATION CURB AND SIDEWALK REMOVAL; which shall include saw cutting, removing and disposing of said structure, all labor, tools, materials and equipment necessary to complete this work as specified.

CURING COMPOUND

This item shall be furnished and applied in accordance with Article 1020.13 of the "Standard Specifications" except as herein provided. Curing Compound shall be applied to all exposed Portland Cement Concrete Surfaces.

This work will not be paid for separately but shall be included in the cost of the item of the construction bid.



SUBMITTED BY:

CONTRACTOR'S NAME

CONTRACTOR'S ADDRESS

CITY, STATE, ZIP

STATE OF ILLINOIS
CITY OF PEORIA
COUNTY OF PEORIA

SPECIFICATIONS, PLANS, MATERIAL
QUANTITIES AND CONTRACT PROPOSAL

FOR

**COLUMBINE DRIVE RECONSTRUCTION – NORTHTRAIL DRIVE TO
HICKORY GROVE ROAD**

TO BE CONSTRUCTED UNDER THE PROVISIONS OF
THE CITY OF PEORIA

BID OPENING:

Thursday, June 16, 2016, 11:00 A.M.



Scott Reese, P.E., City Engineer

TABLE OF CONTENTS

<u>ITEM</u>	<u>PAGE</u>
PROPOSAL ITEMS	
NOTICE TO CONTRACTORS	4
PROPOSAL.....	5
SCHEDULE OF PRICES	8
SIGNATURE PAGE	11
BID BOND	12
SUB-CONTRACTOR UTILIZATION STATEMENT.....	13
M/WBE PARTICIPATION WAIVER REQUEST	15
 GENERAL CONDITIONS	
DESCRIPTION OF WORK	17
ADDITIONAL WORK, CONTRACTOR RESPONSIBILITIES.....	17
DEFINITION OF TERMS	17
FAILURE TO COMPLETE WORK ON TIME.....	18
RESPONSIBILITY FOR DAMAGE CLAIMS	18
QUALIFICATION OF CONTRACTORS	19
CONTRACTOR'S INSURANCE	19
PROOF OF CARRIAGE OF INSURANCE	20
GUARANTEE PERIOD.....	21
PROSECUTION AND PROGRESS OF WORK	21
EXISTING UNDERGROUND FACILITIES	21
COOPERATION WITH UTILITY COMPANIES	21
NOTIFICATION OF UTILITIES PRIOR TO CONSTRUCTION	22
J.U.L.I.E. SYSTEM.....	22
CERTIFIED PAYROLL REQUIREMENTS	22
PREVAILING WAGE PROVISION	22
SUBSTANCE ABUSE PREVENTION PROGRAM.....	28
PROTECTION OF THE PUBLIC.....	29
ITEMS DESIGNATED OR REMOVAL AND EXCAVATION.....	29
CITY SIGNS	29
DAMAGE TO EXISTING TREES	29
SAWCUTTING.....	29
CONTACT PERSON	29
 EQUAL OPPORTUNITY REQUIREMENTS	
EEO CONTRACT COMPLIANCE CLAUSE.....	30
REQUIREMENTS FOR GOOD FAITH EFFORTS.....	33
HUMAN RIGHTS ACT	40
 ROADWORK SPECIAL PROVISIONS	
SALVAGING EXISTING MATERIAL	42
CONSTRUCTION DEBRIS	42
EROSION CONTROL	42
TRENCH BACKFILL.....	43

ITEM	PAGE
INLETS TYPE G-1 (SPECIAL).....	43
TRAFFIC CONTROL AND PROTECTION.....	43
BEAVER DAMS.....	44
INLET MANHOLES, TYPE G-1, 4' DIA., (SPECIAL).....	44
INLET-MANHOLE, TYPE G-1, 4' DIA. (SPECIAL).....	44
AGGREGATE BASE COURSE, CS-01.....	45
AGGREGATE BASE COURSE, CA-6.....	45
TEMPORARY MAILBOX RELOCATION.....	45
UNDERCUTTING SUBABSE.....	45
GEOTECHNICAL FABRIC FOR GROUND STABILIZATION.....	46
P.C.C. DRIVEWAY PAVEMENT, 6".....	46
P.C.C. SIDEWALK, 4".....	46
TREE REMOVAL & RELOCATION.....	44
DETECTABLE WARNINGS.....	47
DRIVEWAY PAVEMENT REMOVAL, PAVEMENT REMOVAL.....	48
CURING COMPOUND.....	48
CONCRETE FIBERS.....	49
SEEDING & MULCHING.....	49
SIDEWALK RAMPS FOR THE DISABLED.....	49
TIE BARS & DOWEL BARS.....	49
RECTANGULAR RAPID FLASHING BEACON WITH TYPE A CONC. BASE.....	49
 APPENDIX A	
EEO DOCUMENTS	
EMPLOYER REPORT CC-1.....	52
MINORITY AND WOMEN BUSINESS ENTERPRISE DIRECTORY.....	53
EQUAL EMPLOYMENT OPPORTUNITY.....	53
MINORITY AND FEMALE WORKFORCE UTILIZATION.....	53
 CONTRACT DELIVERABLES	
SUBCONTRACTOR PAYMENT FORM.....	55
MONTHLY WORKFORCE ANALYSIS.....	56
NOTIFICATION OF CHANGE IN PARTICIPATION.....	57
 MISCELLANEOUS	
SAMPLE CONTRACT.....	59

PROPOSAL ITEMS

STATE OF ILLINOIS
CITY OF PEORIA

NOTICE TO CONTRACTORS

1. Time and Place of Opening Bids.

Sealed proposals for the improvement described herein will be received at the Office of the City Engineer, Public Works Facility, 3505 N. Dries Lane, Peoria, Illinois, until **11:00 A.M., Thursday, June 16, 2016** and at that time publicly opened and read.

2. Description of Work.

(A) Proposed improvement is officially known as, **COLUMBINE DRIVE RECONSTRUCTION – NORTHTRAIL DRIVE TO HICKORY GROVE ROAD.**

(B) The proposed improvement consists of removing existing pavement, sidewalk, curb, curb and gutter, driveways, and driveway approaches and replacing with new roadway, sidewalk, curb, driveway, driveway approaches, curb and gutter, ADA Ramps and all necessary adjustments, incidentals and appurtenances. An alternate bid will be taken on a PCC Base.

3. Instructions to Bidders.

(A) Plans, proposal forms, and specifications for said proposed project may be examined at the Offices of the City Engineer, Public Works Facility, 3505 North Dries Lane, Peoria, IL. Before plans and specifications may be obtained, contractors must be pre-qualified. Complete sets of plans and proposal forms may be obtained on CD at no charge; contact information must be given in exchange for the CD. Each business may receive one CD at no-cost, or request an electronic plan set by email to pwdropbox@peoriagov.org .

(B) All proposals must be accompanied by a proposal guaranty as provided in Section 102 of the “Standard Specifications for Road and Bridge Construction” prepared by the Illinois Department of Transportation: a Bid Bond, or a proposal guarantee of cash, a Bank Cashier Check, or a properly certified check made payable to the City of Peoria, for not less than five percent (5%) of the amount of the bid.

4. Rejection of Bids.

The City of Peoria reserves the right to reject any or all proposals as provided in LRS6 of the “Supplemental Specifications and Recurring Special Provisions” prepared by the Department of Transportation of the State of Illinois, adopted January 1, 2016.

STATE OF ILLINOIS
CITY OF PEORIA

PROPOSAL

1. Proposal of _____
i. (Name and Address of Bidder)
For the improvement, designated in Paragraph 2 below, for the construction of roadway, sidewalk, combination curb and sidewalk, combination curb and gutter, curb, gutter flag, driveway pavement, ADA access ramps.
2. The contract documents for the proposed improvements are those prepared by Mohr & Kerr Engineering & Land surveying, P.C. and the City of Peoria Engineering Department and approved in May 2016 which contract documents are designated as "COLUMBINE DRIVE RECONSTRUCTION – NORTHTRAIL DRIVE TO HICKORY GROVE ROAD".
3. The specifications herein referred to are the "Standard Specifications for Road and Bridge Construction," prepared by the Department of Transportation of the State of Illinois and adopted by said Department on April 1, 2016. The undersigned agrees to accept, as part of the contract, the Special Provisions contained within this proposal.
4. The undersigned declares that he will comply with the applicable provisions of Section 100, General Requirements and Covenants.
5. The undersigned agrees to complete the work, by September 23, 2016 unless additional time is granted in accordance with Article 108.08 of the Specifications.
6. Accompanying this proposal is a bid bond, certified check, or cashier's check complying with the requirements of the Specifications, made payable to the City Treasurer of the City of Peoria, Illinois. If this proposal is accepted and the undersigned fails to execute a contract and contract bond as required, it is hereby agreed that the check shall be forfeited to the awarding authority.

The amount of the check or draft is \$_____.

Attach Cashier's Check or Certified Check Here

7. The undersigned certifies that it is not delinquent in the payment of any indebtedness, tax, fee or fine owed to the City of Peoria, or in the payment of any tax administered by the Illinois Department of Revenue, and is in compliance with the terms and conditions of Sec. 10-109 of the Peoria City Code and 65 ILCS 5/11-42.1-1.
8. Each pay item shall have a unit price and a total price.
9. The unit price shall govern if no total price is shown or if there is a discrepancy between the product of the unit price multiplied by the quantity.
10. If a unit price is omitted, the total price will be divided by the quantity in order to establish a unit price.
11. A bid will be declared unacceptable if neither a unit price nor a total price is shown.
12. The undersigned firm certifies that it has not been convicted of bribery or attempting to bribe an officer or employee of the City of Peoria, nor has the firm made an admission of guilt of such conduct which is a matter of record, nor has an official, agent, or employee of the firm committed bribery or attempted bribery on behalf of the firm and pursuant to the direction or authorization of a responsible official of the firm. The undersigned firm further certifies that it is not barred from contracting with any unit of Federal, State or local government as a result of a violation of State laws prohibiting bid-rigging or bid-rotating and has not been suspended or debarred from receiving federal funding.
13. EMPLOYEE/EMPLOYMENT RESTRICTIONS – THE CONTRACTOR:

THE CONTRACTOR, (hereinafter referred to as “SERVICE PROVIDER”) agrees, as a condition of accepting this contract with the City of Peoria, that, for a period of one (1) year following completion of this contract, it shall be prohibited from hiring, directly or indirectly, any City employee or official who was involved, directly or indirectly in: (1) the selection and/or recommendation to select the SERVICE PROVIDER for performance of this contract; (2) coordinating the efforts of the SERVICE PROVIDER in the consummation or completion of this contract; or (3) monitoring or determining the performance of the SERVICE PROVIDER. The SERVICE PROVIDER further acknowledges and agrees that, upon the City’s determination that a violation of this provision has occurred, the penalty imposed, at the sole discretion of the City, may include one or more of the following: (1) cancellation of any other contract(s) between the City of Peoria and the SERVICE PROVIDER; (2) disqualification of the SERVICE PROVIDER from bidding or being awarded future contracts with the City of Peoria for a period of two [2] years; and/or (3) payment of liquidated damages to the City of Peoria in the amount of TWENTY FIVE THOUSAND DOLLARS (\$25,000.00).

This does not apply to any City Employee involved in the 2011-12 reduction in force; nor does it apply to parties taking the Early Retirement incentive offered by the City from November 1, 2011 through November 1, 2012.

14. EEO CERTIFICATION* (Check one):

_____ We are presently applying for the EEO Certification. Employer Report Form (Form CC-1) is completed and enclosed.

_____ Presently, we have the Employer Report Form (Form CC-1) on file with the City of Peoria, Office of Equal Opportunity and have a current Certificate of Compliance Number.

Certificate of Compliance Number: _____

**Please note there is a \$50.00 processing fee for new and renewal certification requests.*

15. The City of Peoria can increase or decrease this contract up to 25% to meet its budgetary needs.

16. The undersigned submits herewith this Schedules of Prices covering the work to be performed under this contract:

COLUMBINE SCHEDULE OF PRICES - BASE BID

CODE NO.	ITEM	UNIT	QUANTITY	UNIT COST	TOTAL
20200100	EARTH EXCAVATION	CU YD	1219		
20400800	FURNISHED EXCAVATION	CU YD	421		
21101615	TOPSOIL FURNISH AND PLACE, 4"	SQ YD	709		
25200100	SODDING	SQ YD	709		
20101400	NITROGEN FERTILIZER NUTRIENT	POUND	9		
20101500	PHOSPHORUS FERTILIZER NUTRIENT	POUND	9		
20101600	POTASSIUM FERTILIZER NUTRIENT	POUND	9		
21001000	GEOTECHNICAL FABRIC FOR GROUND STABILIZATION	SQ YD	2,959		
28000500	INLET AND PIPE PROTECTION	EACH	5		
40600275	BITUMINOUS MATERIALS (PRIME COAT)	POUND	6,658		
40600290	BITUMINOUS MATERIALS (TACK COAT)	POUND	8,877		
40603080	HOT-MIX ASPHALT BINDER COURSE, IL-19.0, N50, 2 1/2"	TON	414		
40603335	HOT-MIX ASPHALT SURFACE COURSE, MIXTURE "D", N50, 2"	TON	331		
42300200	PCC DRIVEWAY PAVEMENT, 6"	SQ YD	488		
42400800	DETECTABLE WARNINGS	SQ FT	52		
42400100	PORTLAND CEMENT CONCRETE SIDEWALK, 4"	SQ FT	913		
44000100	PAVEMENT REMOVAL	SQ YD	3,582		
44000200	DRIVEWAY PAVEMENT REMOVAL	SQ YD	252		
44000500	COMBINATION CURB AND GUTTER REMOVAL	FOOT	2,104		
44000600	SIDEWALK REMOVAL	SQ FT	231		
550A0340	STORM SEWER, CL. A, TYPE 2, RCP, 12"	FOOT	11		
550A0410	STORM SEWER, CL. A, TYPE 2, RCP, 24"	FOOT	30		
55100500	STORM SEWER REMOVAL, 12"	FOOT	23		
55101200	STORM SEWER REMOVAL, 24"	FOOT	41		
60500040	REMOVING MANHOLES	EACH	2		
60500060	REMOVING INLETS	EACH	3		
60604400	COMBINATION CONCRETE CURB AND GUTTER, TYPE B-6.18	FOOT	2,117		
X0327301	RELOCATE EXISTING MAILBOX	EACH	26		
	TRENCH BACKFILL	TON	133		
	BEAVER DAMS	EACH	7		
	UNDERCUTTING SUBBASE	CY	148		
	GEOTECHNICAL FABRIC FOR BASE REPAIRS (SPECIAL)	SQ YD	296		
	INLET, TYPE G-1 (SPECIAL)	EACH	2		
	INLET MANHOLE, TYPE G-1 (SPECIAL)	EACH	1		
	INLET-MANHOLE, TYPE G-1, 4' DIA. (SPECIAL)	EACH	2		
	AGGREGATE BASE COURSE, CA-6	TON	1,055		
	AGGREGATE BASE COURSE, TYPE B, CS-01, 7"	TON	1,179		

	RECT.RAPID FLASHING BEACON WITH TYPE A CONC. BASE	PAIR	1		
	TREE REMOVAL AND RELOCATION	EACH	2		
	TEMPORARY MAILBOX RELOCATION	L SUM	1		
	TRAFFIC CONTROL AND PROTECTION	L SUM	1		
	CONSTRUCTION STAKING	L SUM	1		
					TOTAL - BASE BID

COLUMBINE SCHEDULE OF PRICES - ALTERNATE BID

CODE NO.	ITEM	UNIT	QUANTITY	UNIT COST	TOTAL
20200100	EARTH EXCAVATION	CU YD	913		
20400800	FURNISHED EXCAVATION	CU YD	421		
21101615	TOPSOIL FURNISH AND PLACE, 4"	SQ YD	709		
25200100	SODDING	SQ YD	709		
20101400	NITROGEN FERTILIZER NUTRIENT	POUND	9		
20101500	PHOSPHORUS FERTILIZER NUTRIENT	POUND	9		
20101600	POTASSIUM FERTILIZER NUTRIENT	POUND	9		
21001000	GEOTECHNICAL FABRIC FOR GROUND STABILIZATION	SQ YD	2,959		
28000500	INLET AND PIPE PROTECTION	EACH	5		
40600290	BITUMINOUS MATERIALS (TACK COAT)	POUND	8,877		
40603335	HOT-MIX ASPHALT SURFACE COURSE, MIXTURE "D", N50, 1 1/2"	TON	249		
42300200	PCC DRIVEWAY PAVEMENT, 6"	SQ YD	488		
42400800	DETECTABLE WARNINGS	SQ FT	52		
42400100	PORTLAND CEMENT CONCRETE SIDEWALK, 4"	SQ FT	913		
44000100	PAVEMENT REMOVAL	SQ YD	3,582		
44000200	DRIVEWAY PAVEMENT REMOVAL	SQ YD	252		
44000500	COMBINATION CURB AND GUTTER REMOVAL	FOOT	2,104		
44000600	SIDEWALK REMOVAL	SQ FT	231		
550A0340	STORM SEWER, CL. A, TYPE 2, RCP, 12"	FOOT	11		
550A0410	STORM SEWER, CL. A, TYPE 2, RCP, 24"	FOOT	30		
55100500	STORM SEWER REMOVAL, 12"	FOOT	23		
55101200	STORM SEWER REMOVAL, 24"	FOOT	41		
60500040	REMOVING MANHOLES	EACH	2		
60500060	REMOVING INLETS	EACH	3		
60604400	COMBINATION CONCRETE CURB AND GUTTER, TYPE B-6.18	FOOT	2,117		
X0327301	RELOCATE EXISTING MAILBOX	EACH	26		
	P.C.C. BASE COURSE, 5"	SQ YD	2,959		
	TRENCH BACKFILL	TON	133		

BEAVER DAMS	EACH	7		
UNDERCUTTING SUBBASE	CY	148		
GEOTECHNICAL FABRIC FOR BASE REPAIRS (SPECIAL)	SQ YD	296		
INLET, TYPE G-1 (SPECIAL)	EACH	2		
INLET MANHOLE, TYPE G-1 (SPECIAL)	EACH	1		
INLET-MANHOLE, TYPE G-1, 4' DIA. (SPECIAL)	EACH	2		
AGGREGATE BASE COURSE, CA-6	TON	1,223		
RECTANGULAR RAPID FLASHING BEACON WITH TYPE A CONCRETE BASE	PAIR	1		
TREE REMOVAL AND RELOCATION	EACH	2		
TEMPORARY MAILBOX RELOCATION	L SUM	1		
TRAFFIC CONTROL AND PROTECTION	L SUM	1		
CONSTRUCTION STAKING	L SUM	1		
TOTAL - ALTERNATE BID				

The undersigned further agrees that if awarded the contract for the sections contained in the following combinations, he will perform the work in accordance with the requirements of each individual proposal for the multiple bid specified in the schedule below.

(If an individual) Signature of Bidder _____

Business Address _____

(If a partnership) Firm Name _____

Signed by _____
President

Business Address _____

Insert Names _____
and Addresses _____
of all partners: _____

(If a corporation) Corporate Name _____

Signed by _____

Business Address _____

Insert Names
of Officers:

President

Secretary

Treasurer

Attest: _____
Secretary



Proposal Bid Bond

RETURN WITH BID

Route
Municipality City of Peoria
Rd. Dist./Twnshp
County Peoria
Section

WE _____ as PRINCIPAL, an _____ as SURETY,

are held and firmly bound unto THE CITY OF PEORIA (hereafter referred to as "LA") in the penal sum of 5% of the total bid price, or for the amount specified in Article 102.09 of the "Standard Specifications for Road and Bridge Construction" in effect on the date of invitation for bids. We bind ourselves, our heirs, executors, administrators, successors, and assigns, jointly to pay to the LA this sum under the conditions of this instrument.

WHEREAS THE CONDITION OF THE FOREGOING OBLIGATION IS SUCH that, the said PRINCIPAL is submitting a written proposal to the LA acting through its awarding authority for the construction of the work designated as the above section.

THEREFORE if the proposal is accepted and a contract awarded to the PRINCIPAL by the LA for the above designated section and the PRINCIPAL shall within fifteen (15) days after award enter into a formal contract, furnish surety guaranteeing the faithful performance of the work, and furnish evidence of the required insurance coverage, all as provided in the "Standard Specifications for Road and Bridge Construction" and applicable Supplemental Specifications, then this obligation shall become void; otherwise it shall remain in full force and effect.

IN THE EVENT the LA determines the PRINCIPAL has failed to enter into a formal contract in compliance with any requirements set forth in the preceding paragraph, then the LA acting through its awarding authority shall immediately be entitled to recover the full penal sum set out above, together with all court costs, all attorney fees, and any other expense of recovery.

IN TESTIMONY WHEREOF, the said PRINCIPAL and the said SURETY have caused this instrument to be signed by their respective officers this _____ day of _____ A.D. _____

Principal

(Company Name) (Company Name)
By: (Signature and Title) By: (Signature and Title)

(If PRINCIPAL is a joint venture of two or more contractors, the company names, and authorized signatures of each contractor must be affixed.)

Surety

(Name of Surety) By: (Signature of Attorney-in-Fact)

STATE OF ILLINOIS,

COUNTY OF _____

I, _____, a Notary Public in and for said county,

do hereby certify that _____ (Insert names of individuals signing on behalf of PRINCIPAL & SURETY)

who are each personally known to me to be the same persons whose names are subscribed to the foregoing instrument on behalf of PRINCIPAL and SURETY, appeared before me this day in person and acknowledged respectively, that they signed and delivered said instruments as their free and voluntary act for the uses and purposes therein set forth.

Given under my hand and notarial seal this _____ day of _____ A.D. _____

NOTICE
1. Improper execution of this form (i.e. missing signatures or seals or incomplete certification) will result in bid being declared irregular.
2. If bid bond is used in lieu of proposal guaranty check, it must be on this form and must be submitted with bid

My commission expires _____

(Notary Public)



CITY OF PEORIA SUBCONTRACTOR UTILIZATION STATEMENT

Section I (select all that apply)

MBE/WBE Subcontractor(s) will be utilized on this project
 Non MBE/WBE Subcontractor(s) will be utilized on this project

**Section II
PRIME CONTRACTOR**

PROJECT

Name: _____
 Address: _____
 Phone: _____
 Contact Person: _____
 Email: _____
 Ownership Status: MBE _____ WBE _____ M/WBE _____ Non-M/WBE _____

Name: _____
 Total Contract Value: _____

Section III: Selected Subcontractors

Subcontractor Name	MBE, WBE or Non M/WBE	Amount	% of Total Contract	Scope of Work
TOTALS				

**If more than seven firms are utilized, please copy the form and attach the additional information.*

Section IV: Subcontractors that submitted bids but were not selected (M/WBE Only)

Subcontractor Name	Scope of Work Bid	Denial Reason

**If more than seven firms submitted quotes, please copy the form and attach the additional information.*

For Office Use Only
 Reviewed by: _____

Section V: Subcontractors Contacted (M/WBE Only)

Subcontractor Name	Method of Contact	Contact Outcome

**If more than seven firms were contacted, please copy the form and attach the additional information.*

Section VI

The City of Peoria is committed to promoting equal opportunity and has established the following subcontractor utilization goals for city funded construction projects: 10% MBE and 5% WBE. Prime Contractors have an obligation to make a good faith effort to advance the city's commitment to increase diversity among the firms working on city construction projects.

This form must be completed and submitted with bid proposals. ALL subcontractors intended for use on this project shall be listed in Section III above; along with the total amount to be paid to the subcontractors; percentage of total contract; and scope of work. If for whatever reason the prime contractor has to utilize a subcontractor not listed above, they must submit a Notification of Change in Participation.

The undersigned certifies that the information included herein is true and correct; the subcontractors listed above have agreed to perform the scope of work described. The undersigned further certifies that it has no controlling, dominating or conflict of interest in any of the listed subcontractors.

Signature of Prime Contractor

Date

Org.: May 2008
Revised: Feb. 2011

For Office Use Only
Reviewed by: _____

**CITY OF PEORIA
M/WBE PARTICIPATION WAIVER REQUEST**

PRIME CONTRACTOR

PROJECT

Name: _____

Name: _____

Address: _____

Phone: _____

Contact Person: _____

We hereby request to waive all of the MBE and WBE participation goals on the above named project and self-perform all work for the following reason(s). The firm further affirms that the stated reasons and documents provided are true and correct and not misleading: **(CHECK ALL THAT APPLY. SPECIFIC SUPPORTING DOCUMENTATION MUST BE SUBMITTED WHERE INDICATED.)**

- 1. No MBEs/WBEs responded to our invitation to bid. _____
- 2. No subcontracting opportunities exist. (Attach explanation) _____
- 3. The award of subcontract(s) is impracticable. (Attach explanation) _____

SIGNED: _____
(Company Official)

DATE: _____

FOR OFFICE USE ONLY

APPROVED

DISAPPROVED

REVIEWED BY _____

DATE _____

GENERAL CONDITIONS

STATE OF ILLINOIS
CITY OF PEORIA

SPECIAL PROVISIONS

The following Special Provisions supplement the "Standard Specifications for Road and Bridge Construction," adopted April 1, 2016, the latest edition of the "Illinois Manual on Uniform Traffic Control Devices for Streets and Highways" in effect on the date of invitation for bids, the "Standard Specifications for Traffic Control Items," adopted January 1, 2002 and the "Supplemental Specifications and Recurring Special Provisions", included herein which apply to and govern the construction of the COLUMBINE DRIVE RECONSTRUCTION – NORTHTRAIL DRIVE TO HICKORY GROVE ROAD, in the City of Peoria, Peoria County, and in case of conflict with any part of said specifications, the said Special Provisions shall take precedence and shall govern.

DESCRIPTION OF WORK

The COLUMBINE DRIVE RECONSTRUCTION – NORTHTRAIL DRIVE TO HICKORY GROVE ROAD proposed improvement consists of roadway removal and replacement with a HMA roadway, improvements include curb and gutter, sidewalks, and driveways. The improvement is on COLUMBINE DRIVE between Hickory Grove Road and Northtrail Drive.

ADDITIONAL WORK, CONTRACTOR RESPONSIBILITY

The Contractor shall be responsible for coordinating additional work with a property owner. Additional work shall be defined as any work requested by the property owner that was not originally planned by the City or its Consultant. Typical forms of additional work will be driveway approaches and adjustments beyond the limits of the City's planned improvements, privacy walks between the sidewalk and curb; private walks and steps behind the sidewalk, private tree trimming/removal; replacement of private retaining wall not otherwise damaged by contractor, and replacement of sidewalk, curb, or other items that were not agreed upon by the City.

The City will participate in the necessary adjustments to driveways in the front and back of the sidewalk. The city will also participate in private walk & step adjustments as needed up to 5 feet in the front and back of the sidewalk. Any additional items needed or requested by the property will be considered additional work.

The respective property owner shall bear the financial responsibility for any additional work as defined above. It is the contractor's responsibility to negotiate and establish an agreed price with any property owner where additional work is required. The city has no obligation, financial or otherwise, as it pertains to additional work.

DEFINITION OF TERMS

Section 101 of the Standard Specifications shall be revised as follows:

Article 101.14 Department. The City of Peoria or its Representative.

Article 101.16 Engineer. The designated employee or representative of the City of Peoria.

The Engineer will not be responsible for construction means, methods, techniques, sequences, or procedures, or for safety precautions and programs.

Article 101.19 Inspector. The authorized representative of the Engineer assigned to make detailed observations or any or all portions of the work or material therefore.

This activity is not to be interpreted as an inspection service, a construction supervision service, or a guaranteeing of the Contractor's performance. The Inspector will not be responsible for construction means, methods, techniques, sequences, or procedures, or for safety precautions and programs. The Inspector will not be responsible for the Contractor's obligation to carry out the work in accordance with the Contract Documents.

FAILURE TO COMPLETE WORK ON TIME

Should the Contractor fail to complete the work by **September 23, 2016**, the Contractor shall be liable to the City of Peoria at a rate of \$750.00 per day for every day worked over the contract time to cover all costs incurred for engineering, inspection and other expenses incurred by the City of Peoria by reason of the Contractor's failure to complete the work within the specified time, and such amount shall be deducted from the monies due the Contractor, not as a penalty, but as damages sustained.

RESPONSIBILITY FOR DAMAGE CLAIMS

The Contractor shall indemnify and save harmless the CITY OF PEORIA, its officers, agents, and employees against all loss, damage or expense that it or they may sustain as a result of any suits, actions, or claims of any character brought on account of injury to or death of any person or persons, including all persons performing any work under this contract, which may arise in any way (except for a negligent act of the City of Peoria, its officers or employees) in connection with the work to be performed under this contract, including but not limited to, suits, actions or claims arising under "An Act providing for the protection and safety of persons in and about the construction, repairing, alteration or removal of building, bridges, viaducts, and other structures, and to provide for the enforcement thereof," approved June 3, 1907, (740 ILCS 150/1), as amended: the Contractor shall also indemnify and save harmless the CITY OF PEORIA, its officers and employees, from all suits, actions, or claims of any character brought because of any injuries or damages received or sustained by any person, persons, or property, on account of, or in consequence of, any neglect by Contractor or a Subcontractor in safeguarding the work; or through use of unacceptable materials in constructing the work; or because of any act or omission, neglect, or misconduct of said Contractor; or because of any claims or amounts recovered for any infringements of patent, trademark, or copyright, or from any claims or amounts arising or recovered under the "Workers Compensation Act," or any other law, ordinance, order, or decree, and so much of the money due the said Contractor under and by virtue of his contract as shall be considered necessary by the Department for such purposes, may be retained for the use of the ENGINEERING DIVISION; or, in case no money is due, his surety shall be held until such suits, actions, or claims have been settled and suitable evidence to that effect furnished to the Department.

QUALIFICATION OF CONTRACTORS

Contractors shall be qualified before plans and proposal documents will be provided for bidding. In general, contractors qualified by the State of Illinois, Department of Transportation to perform the work indicated in the proposal will be acceptable to the City of Peoria, Engineering Division; but, the City Engineer reserves the right to refuse to accept a bid from a State-qualified contractor and will state his reasons, in writing, for said refusal if requested by the contractor.

Contractors who have done similar work and an improvement of similar size for the City in the past normally are qualified by their past performances.

Contractors not qualified as indicated above shall be required to submit a listing of jobs of a similar nature with an indication of the dollar value of said jobs and the person or company for whom the work was performed so that a check of the quality of the work can be made, as well as the performance and financial ability of the contractor. The City Engineer will approve or disapprove the contractor, and the decision shall be final. If desired by the contractor, the City Engineer will provide his reasons for disapproving any contractor from bidding on the proposed improvement.

CONTRACTOR'S INSURANCE

The Contractor shall not commence work under this project until he has obtained all insurance required under this paragraph and such insurance has been approved by the City of Peoria, nor shall the Contractor allow any Subcontractor to commence work on his subcontract until all similar insurance required of the Subcontractor has been so obtained and approved by the City of Peoria.

The Contractor shall require Subcontractors, if any, not protected under the Contractor's insurance policies as an additional insured to take out and maintain insurance of such nature in amounts not less than that required of the principal Contractor, excluding Umbrella Coverage and Owner's Protective Liability and Property Damage Insurance, and any and all insurance obtained by any Subcontractor or Subcontractors shall be approved by the City of Peoria.

All policies shall contain provisions to the effect that in the event of payment of any loss or damage the insurers will have no rights of recovery against any of the insured or additional insureds there under.

COMPENSATION INSURANCE

The Contractor shall take out and maintain during the life of this project Worker's Compensation Insurance for all of his employees employed at the site of the project and, in case any work is sublet, the Contractor shall require the Subcontractor similarly to provide Worker's Compensation Insurance for all of the latter's employees unless such employees are covered by the protection afforded by the Contractor, and any such insurance obtained by any subcontractor or subcontractors shall be approved by the City of Peoria. In case any class of employees engaged in hazardous work at the site of the project is not protected under the Worker's Compensation statute, the Contractor shall provide, and shall cause each Subcontractor to provide adequate insurance coverage for the protection of his employees not otherwise protected, such as accident insurance, and any such insurance shall be approved by the City of Peoria.

PUBLIC LIABILITY AND PROPERTY DAMAGE INSURANCE

The Contractor shall take out and maintain during the life of the project such General Liability, Public Liability and Property Damage Insurance as shall protect him and any Subcontractor performing work covered by this project, from claims for damages for personal injury, including accidental death, as well as from claims for property damages, which may arise from operations under this project, whether such operations be by himself or by any Subcontractors or by anyone directly or indirectly employed by either of them and the amounts of such insurance shall be as follows:

Commercial General Liability Insurance that provides Property Damage and/or Bodily Injury in an amount not less than \$1,000,000 per occurrence and \$2,000,000 aggregate.

OWNER'S PROTECTIVE LIABILITY AND PROPERTY DAMAGE INSURANCE

The Contractor shall obtain Owner's Protective Liability and Property Damage Insurance in an amount not less than \$1,000,000 per occurrence and \$2,000,000 aggregate. If endorsements to the above public liability and property damage insurance policies cannot be made, then separate policies providing such protection must be furnished by the Contractor.

AUTOMOBILE INSURANCE

The Contractor shall take out and maintain during the life of the project such automobile insurance covering all owned and non-owned vehicles as shall protect him and any Subcontractor performing work covered by this project, from claims for damages in an amount not less than \$1,000,000 Combined Bodily Injury and Property Damage.

UMBRELLA COVERAGE

The Contractor shall take out and maintain during the life of the project such Umbrella or Excess Liability coverage as shall protect him and any Subcontractor performing work covered by this project, from claims for damages in an amount not less than \$2,000,000 per occurrence and \$5,000,000 annual aggregate.

ADDITIONAL INSURED ENDORSEMENT

All Liability insurance policies shall name the City of Peoria its officers, directors, employees, agents, representatives, subsidiaries, successors, and assigns, as additional insureds, shall be primary to any other insurance carried by the City of Peoria and shall provide coverage consistent with ISO CG 20 26, and shall maintain the required coverages, naming the City of Peoria as an additional insured, for a period of not less than three years from the date the City of Peoria and Contractor execute an Agreement to Final Quantities.

PROOF OF CARRIAGE OF INSURANCE

The Contractor and all Subcontractors shall furnish the City of Peoria with satisfactory proof of insurance coverage. This shall include an A.M. Best "A" rating before the project begins. If coverage is cancelled or the carrier's rating falls below A.M. Best "A" rated, the City of Peoria shall be notified in writing.

Certificates of insurance are required. The Certificate must state the following "The City of Peoria, its officers, directors, employees, agents, and representatives, are named as Additional Insured on a primary basis for liability arising out of the contractor's operations."

Upon request the Contractor must provide copies of the policies and endorsements, failure to provide the required certificates of insurance shall not operate to invalidate the insurance requirements under this Contract.

GUARANTEE PERIOD

The Contractor warrants all work performed under this contract is free from defects and was performed in accordance with the Contract Documents for a period of one (1) year from the date of agreement of final quantities, as agreed in writing, by the City Engineer after all parties have signed the document. In case of acceptance of a part of the work for use prior to the agreement to final quantities, the guarantee for the part so accepted shall be for a period of one (1) year from the date of such partial acceptance, in writing, by the City Engineer. Work performed due to this warranty requirement shall be guaranteed for a period of one (1) year. The Guarantee Period may be further amended in the Roadwork Special Provision.

PROSECUTION AND PROGRESS OF WORK

Special attention is called to Section 108 of the "Standard Specifications for Road and Bridge Construction," and specifically to Article 108.03, which states that the Contractor shall notify the Engineer at least twenty-four (24) hours in advance of either discontinuing or resuming operations.

If an Engineer or an Inspector for the City of Peoria Engineering Division is not on the job and notification as required has been given, the contractor in charge of the work shall immediately notify the Engineering Division that work has been resumed and request that the Project Engineer in charge of work for the City Engineering Division be notified.

Work performed without proper notification to the City Engineering Division as indicated herein may be rejected by the Engineer for the City of Peoria and no compensation will be made for said work. In addition, the contractor may be required to remove the item of construction at its own expense and replace the item of construction in accordance with the plans and specifications.

EXISTING UNDERGROUND FACILITIES

The City of Peoria assumes no responsibility for the presence, specific size or location of underground distribution systems of the several public utility corporations. No responsibility for the protection of said underground systems will be assumed by the City of Peoria unless such protection is incidental to the protection of the municipally-owned property of the City of Peoria. If such protection is found to be necessary to water mains, gas mains, steam mains, underground electrical distribution systems, underground telephone circuit systems or any other underground systems of non-municipal ownership, the cost of same, in whole or in part, is disclaimed by the City of Peoria.

COOPERATION WITH UTILITY COMPANIES

It is understood and agreed that the contractor has considered, in his bid, all the permanent and temporary utility appurtenances in their present or relocated positions and that no additional compensation will be allowed for any delays, inconvenience or damage sustained by him due to any interference from the said utility appurtenances or the operations of moving them.

All telephone, cableway, gas, water and wire lines, within the limits of the proposed construction owned by various utility companies, are to be moved by the owners of the particular utility involved at the owner's expense.

NOTIFICATION OF UTILITIES PRIOR TO CONSTRUCTION

All utility companies must be notified by the Contractor, in writing, at least one (1) week in advance prior to starting construction so that they will have adequate time to locate and mark their utility locations in the field and twenty-four (24) hours prior to commencing actual construction work. All utility companies must be notified so that they may have personnel on the job site to assist in locating their utility lines and avoid damage to their utilities. Specifically, AmerenCILCO, Comcast Communications, SBC, McLeod Communications and the Illinois-American Water Co., have requested that they be notified prior to the start of construction. A copy of the letter notifying the utility companies of the Contractor's intention to start work must be received by the City of Peoria Engineering Division before the Contractor will be permitted to start construction.

J.U.L.I.E. SYSTEM

The J.U.L.I.E. (Joint Utility Locating Information for Excavators) must be notified prior to starting construction, so that the respective utilities may have adequate time to locate and mark their underground facilities. Phone: 1-800-892-0123 or 811.

CERTIFIED PAYROLL REQUIREMENTS

Contractors and subcontractors on public works projects must submit certified payroll records on a monthly basis to the public body in charge of the construction project, along with a statement affirming that such records are true and accurate, that the wages paid to each worker are not less than the required prevailing rate, and that the contractor is aware that filing records he or she knows to be false is a Class B Misdemeanor. The Certified Payroll Records must include, for every worker employed on the public works project, the name, address, telephone number, social security number, job classification, hourly wages paid in each pay period, number of hours worked each day, and starting and ending time of work each day. Certified payrolls are to be submitted on EPrismSoft, per the EEO guidelines outlined in Section VII of the Good Faith Efforts Requirements, herein.

PREVAILING WAGE PROVISION

This contract is for the performance of "public works" as that term is defined by 820 ILCS 130/2. Not less than the prevailing rate of wages as found by the Illinois Department of Labor or determined by a Court on review shall be paid to all laborers, workers and mechanics performing work under this contract. These prevailing rates of wages are revised on a monthly basis and can be found on the Illinois Department of Labor's website.

It shall be the contractor's responsibility to monitor the prevailing wages and adjust his payroll accordingly as soon as any rates are revised by the Department of Labor.

TRUCK DRIVER	ALL 1	33.000	36.550	1.5	1.5	2.0	11.10	5.230	0.000	0.250
TRUCK DRIVER	ALL 2	33.480	36.550	1.5	1.5	2.0	11.10	5.230	0.000	0.250
TRUCK DRIVER	ALL 3	33.700	36.550	1.5	1.5	2.0	11.10	5.230	0.000	0.250
TRUCK DRIVER	ALL 4	34.010	36.550	1.5	1.5	2.0	11.10	5.230	0.000	0.250
TRUCK DRIVER	ALL 5	34.900	36.550	1.5	1.5	2.0	11.10	5.230	0.000	0.250
TRUCK DRIVER	O&C 1	27.280	30.220	1.5	1.5	2.0	11.40	5.440	0.000	0.250
TRUCK DRIVER	O&C 2	27.680	30.220	1.5	1.5	2.0	11.40	5.440	0.000	0.250
TRUCK DRIVER	O&C 3	27.860	30.220	1.5	1.5	2.0	11.40	5.440	0.000	0.250
TRUCK DRIVER	O&C 4	28.110	30.220	1.5	1.5	2.0	11.40	5.440	0.000	0.250
TRUCK DRIVER	O&C 5	28.850	30.220	1.5	1.5	2.0	11.40	5.440	0.000	0.250
TUCKPOINTER	BLD	32.380	33.880	1.5	1.5	2.0	8.600	9.870	0.000	0.590

Legend: RG (Region)

TYP (Trade Type - All, Highway, Building, Floating, Oil & Chip, Rivers)

C (Class)

Base (Base Wage Rate)

FRMAN (Foreman Rate)

M-F>8 (OT required for any hour greater than 8 worked each day, Mon through Fri.)

OSA (Overtime (OT) is required for every hour worked on Saturday)

OSH (Overtime is required for every hour worked on Sunday and Holidays)

H/W (Health & Welfare Insurance)

Pensn (Pension)

Vac (Vacation)

Trng (Training)

Explanations

PEORIA COUNTY

The following list is considered as those days for which holiday rates of wages for work performed apply: New Years Day, Memorial Day, Fourth of July, Labor Day, Thanksgiving Day, Christmas Day and Veterans Day in some classifications/counties. Generally, any of these holidays which fall on a Sunday is celebrated on the following Monday. This then makes work performed on that Monday payable at the appropriate overtime rate for holiday pay. Common practice in a given local may alter certain days of celebration. If in doubt, please check with IDOL.

Oil and chip resealing (O&C) means the application of road oils and liquid asphalt to coat an existing road surface, followed by application of aggregate chips or gravel to coated surface, and subsequent rolling of material to seal the surface.

EXPLANATION OF CLASSES

ASBESTOS - GENERAL - removal of asbestos material/mold and hazardous materials from any place in a building, including mechanical systems where those mechanical systems are to be removed. This includes the removal of asbestos materials/mold and hazardous materials from ductwork or pipes in a building when the building is to be demolished at the time or at some close future date.

ASBESTOS - MECHANICAL - removal of asbestos material from mechanical systems, such as pipes, ducts, and boilers, where the mechanical systems are to remain.

CERAMIC TILE FINISHER, MARBLE FINISHER, TERRAZZO FINISHER

Assisting, helping or supporting the tile, marble and terrazzo mechanic by performing their historic and traditional work assignments required to complete the proper installation of the work covered by said crafts. The term "Ceramic" is used for naming the classification only and is in no way a limitation of the product handled. Ceramic takes into consideration most hard tiles.

ELECTRONIC SYSTEMS TECHNICIAN

Installation, service and maintenance of low-voltage systems which utilizes the transmission and/or transference of voice, sound, vision, or digital for commercial, education, security and entertainment purposes for the following: TV monitoring and surveillance, background/foreground music, intercom and telephone interconnect, field programming, inventory control systems, microwave transmission, multi-media, multiplex, radio page, school, intercom and sound burglar alarms and low voltage master clock systems.

Excluded from this classification are energy management systems, life safety systems, supervisory controls and data acquisition systems not intrinsic with the above listed systems, fire alarm systems, nurse call systems and raceways exceeding fifteen feet in length.

LABORER, SKILLED - BUILDING

The skilled laborer building (BLD) classification shall encompass the following types of work, irrespective of the site of the work: cutting & acetylene torch, gunnite nozzlemen, gunnite pump men & pots, kettlemen & carriers of men handling hot stuff, sandblaster nozzle men, sandblasting pump men & pots, setting up and using concrete burning bars, wood block setters, underpinning & shoring of existing buildings, and the unloading and handling of all material coated with creosote.

LABORER, SKILLED - HIGHWAY

The skilled laborer heavy & highway (HWY) classification shall encompass the following types of work, irrespective of the site of the work: jackhammer & drill operator, gunite pump & pot man, puddlers, vibrator men, wire fabric placer, sandblast pump & pot man, strike off concrete, unloading, handling & carrying of all creosoted piles, ties or timber, concrete burning bars, power wheelbarrows or buggies, asphalt raker, brickset-ters, cutting torchman (electric & acetylene), men setting lines to level forms, form setters, gunite nozzle man & sandblasting nozzle man, power man, and rip-rapping by hand.

SURVEY WORKER - Operated survey equipment including data collectors, G.P.S. and robotic instruments, as well as conventional levels and transits.

TRUCK DRIVER - BUILDING, HEAVY AND HIGHWAY CONSTRUCTION

Class 1. Drivers on 2 axle trucks hauling less than 9 ton. Air compressor and welding machines and brooms, including those pulled by separate units, truck driver helpers, warehouse employees, mechanic helpers, greasers and tiremen, pickup trucks when hauling materials, tools, or workers to and from and on-the-job site, and fork lifts up to 6,000 lb. capacity.

Class 2. Two or three axle trucks hauling more than 9 ton but hauling less than 16 ton. A-frame winch trucks, hydrolift trucks, vector trucks or similar equipment when used for transportation purposes. Fork lifts over 6,000 lb. capacity, winch trucks, four axle combination units, and ticket writers.

Class 3. Two, three or four axle trucks hauling 16 ton or more. Drivers on water pulls, articulated dump trucks, mechanics and working forepersons, and dispatchers. Five axle or more combination units.

Class 4. Low Boy and Oil Distributors.

Class 5. Drivers who require special protective clothing while employed on hazardous waste work.

TRUCK DRIVER - OIL AND CHIP RESEALING ONLY.

This shall encompass laborers, workers and mechanics who drive contractor or subcontractor owned, leased, or hired pickup, dump, service, or oil distributor trucks. The work includes transporting materials and equipment (including but not limited to, oils, aggregate supplies, parts, machinery and tools) to or from the job site; distributing oil or liquid asphalt and aggregate; stock piling material when in connection with the actual oil and chip contract. The Truck Driver (Oil & Chip Resealing) wage classification does not include supplier delivered materials.

OPERATING ENGINEERS - BUILDING

Class 1. Cranes; Overhead Cranes; Gradall; All Cherry Pickers; Mechanics; Central Concrete Mixing Plant Operator; Road Pavers (27E - Dual Drum - Tri Batchers); Blacktop Plant Operators and Plant Engineers; 3 Drum Hoist; Derricks; Hydro Cranes; Shovels; Skimmer Scoops; Koehring Scooper; Drag Lines; Backhoe; Derrick Boats; Pile Drivers and Skid Rigs; Clamshells; Locomotive Cranes; Dredge (all types) Motor Patrol; Power Blades - Dumore - Elevating and similar types; Tower Cranes (Crawler-Mobile) and Stationary; Crane-type Backfiller; Drott Yumbo and similar types considered as Cranes; Caisson Rigs; Dozer; Tournadozer; Work Boats; Ross Carrier; Helicopter; Tournapulls - all and similar types; Scoops (all sizes); Pushcats; Endloaders (all types); Asphalt Surfacing Machine; Slip Form Paver; Rock Crusher; Heavy Equipment Greaser; CMI, CMI Belt Placer, Auto Grade & 3 Track and similar types; Side Booms; Multiple Unit Earth Movers; Creter Crane; Trench Machine; Pump-crete-Belt Crete-Squeeze Cretes-Screw-type Pumps and Gypsum; Bulker & Pump - Operator will clean; Formless Finishing Machine; Flaherty Spreader or similar types; Screed Man on Laydown Machine; Wheel Tractors (industrial or Farm-type w/Dozer-Hoe-Endloader or other attachments); F.W.D. & Similar Types; Vermeer Concrete Saw.

Class 2. Dinkeys; Power Launches; PH One-pass Soil Cement Machine (and similar types); Pugmill with Pump; Backfillers; Euclid Loader; Forklifts; Jeeps w/Ditching Machine or other attachments; Tunneluger; Automatic Cement and Gravel Batching Plants; Mobile Drills (Soil Testing) and similar types; Gurries and Similar Types; (1) and (2) Drum Hoists (Buck Hoist and Similar Types); Chicago Boom; Boring Machine & Pipe Jacking Machine; Hydro Boom; Dewatering System; Straw Blower; Hydro Seeder; Assistant Heavy Equipment Greaser on Spread; Tractors (Track type) without Power Unit pulling Rollers; Rollers on Asphalt -- Brick Macadam; Concrete Breakers; Concrete Spreaders; Mule Pulling Rollers; Center Stripper; Cement Finishing Machines & CMI Texture & Reel Curing Machines; Cement Finishing Machine; Barber Green or similar loaders; Vibro Tamper (All similar types) Self-propelled; Winch or Boom Truck; Mechanical Bull Floats; Mixers over 3 Bag to 27E; Tractor pulling Power Blade or Elevating Grader; Porter Rex Rail; Clary Screed; Truck Type Hoptoe Oilers; Fireman; Spray Machine on Paving; Curb Machines; Truck Crane Oilers; Oil Distributor; Truck-Mounted Saws.

Class 3. Air Compressor; Power Subgrader; Straight Tractor; Trac Air without attachments; Herman Nelson Heater, Dravo, Warner, Silent Glo, and similar types; Roller Five (5) Ton and under on Earth or Gravel; Form Grader; Crawler Crane & Skid Rig Oilers; Freight Elevators - permanently installed; Pump; Light Plant; Generator; Conveyor (1) or (2) - Operator will clean; Welding Machine; Mixer (3) Bag and Under (Standard Capacity with skip); Bulk Cement Plant; Oiler

on Central Concrete Mixing Plant.

OPERATING ENGINEERS - HEAVY AND HIGHWAY CONSTRUCTION

CLASS 1. Cranes; Hydro Cranes; Shovels; Crane Type Backfiller; Tower, Mobile, Crawler, & Stationary Cranes; Derricks; Hoists (3 Drum); Draglines; Drott Yumbo & Similar Types considered as Cranes; 360 Degree Swing Excavator (Shears, Grapples, Movacs, etc.); Back Hoe; Derrick Boats; Pile Driver and Skid Rigs; Clam Shell; Locomotive - Cranes; Road Pavers - Single Drum - Dual Drum - Tri Batcher; Motor Patrols & Power Blades - Dumore - Elevating & Similar Types; Mechanics; Central Concrete Mixing Plant Operator; Asphalt Batch Plant Operators and Plant Engineers; Gradall; Caisson Rigs; Skimmer Scoop - Koering Scooper; Dredges (all types); Hoptoe; All Cherry Pickers; Work Boat; Ross Carrier; Helicopter; Dozer; Tournadozer; Tournapulls - all and similar types; Operation of Concrete and all Recycle Machines; Multiple Unit Earth Movers; Scoops (all sizes); Pushcats; Endloaders (all types); Asphalt Surfacing Machine; Slip Form Paver; Rock Crusher; Operation of Material Crusher, Screening Plants, and Tunnel Boring Machine; Heavy Equipment Greaser (top greaser on spread); CMI, Auto Grade, CMI Belt Placer & 3 Track and Similar Types; Side Booms; Asphalt Heater & Planer Combination (used to plane streets); Wheel Tractors (with Dozer, Hoe or Endloader Attachments); CAT Earthwork Compactors and Similar Types; Blaw Knox Spreader and Similar Types; Trench Machines; Pump Crete - Belt Crete - Squeeze Crete - Screw Type Pumps and Gypsum (operator will clean); Creter Crane; Operation of Concrete Pump Truck; Formless Finishing Machines; Flaherty Spreader or Similar Types; Screed Man on Laydown Machine; Vermeer Concrete Saw; Operation of Laser Screed; Span Saw; Dredge Leverman; Dredge Engineer; Lull or Similar Type; Hydro-Boom Truck; Operation of Guard Rail Machine; and Starting Engineer on Pipeline or Construction (11 or more pieces) including: Air Compressor (Trailer Mounted), All Forced Air Heaters (regardless of Size), Water Pumps (Greater than 4-1/2" or Total Discharge Over 4-1/2"), Light Pumps, Generators (Trailer Mounted - Excluding Decontamination Trailer), Welding Machines (Any Size or Mode of Power), Conveyor, Mixer (any size), Stud Welder, Power Pac, etc, and Ground Heater (Trailer Mounted).

CLASS 2. Bulker & Pump; Power Launches; Boring Machine & Pipe Jacking Machine; Dinkeys; Operation of Carts, Powered Haul Unit for a Boring Machine; P & H One Pass Soil Cement Machines and Similar Types; Wheel Tractors (Industry or Farm Type - Other); Back Fillers; Euclid Loader; Fork Lifts; Jeep w/Ditching Machine or Other Attachments; Tunneluger; Automatic Cement & Gravel Batching Plants; Mobile Drills - Soil Testing and Similar Types; Pugmill with Pump; All (1) and (2) Drum Hoists; Dewatering System; Straw Blower; Hydro-Seeder; Bump Grinders (self-propelled); Assistant Heavy Equipment Greaser; Apsco Spreader; Tractors (Track-Type) without Power Units Pulling Rollers; Rollers on Asphalt - Brick or Macadam; Concrete Breakers; Concrete Spreaders; Cement Strippers; Cement Finishing Machines & CMI Texture & Reel Curing Machines; Vibro-Tampers (All Similar Types Self-Propelled); Mechanical Bull Floats; Self-Propelled Concrete Saws; Truck Mounted Power Saws; Operation of Curb Cutters; Mixers - Over Three (3) Bags; Winch and Boom Trucks; Tractor Pulling Power Blade or Elevating Grader; Porter Rex Rail; Clary Screed; Mule Pulling Rollers; Pugmill without Pump; Barber Greene or Similar Loaders; Track Type Tractor w/Power Unit attached (minimum); Fireman; Spray Machine on Paving; Curb Machines; Paved Ditch Machine; Power Broom; Self-Propelled Sweepers; Self-Propelled Conveyors; Power Subgrader; Oil Distributor; Straight Tractor; Truck Crane Oiler; Truck Type Oilers; Directional Boring Machine; Horizontal Directional Drill; Articulating End Dump Vehicles; Starting Engineer on Pipeline or Construction (6 -10 pieces) including: Air Compressor (Trailer Mounted), All Forced Air

Heaters (regardless of Size), Water Pumps (Greater than 4-1/2" or Total Discharge Over 4-1/2"), Light Plants, Generators (Trailer Mounted - Excluding Decontamination Trailer), Welding Machines (Any Size or Mode of Power), Conveyor, Mixer (any size), Stud Welder, Power Pac, etc., and Ground Heater (Trailer Mounted).

CLASS 3. Straight Framed Truck Mounted Vac Unit (separately powered); Trac Air Machine (without attachments); Rollers - Five Ton and Under on Earth and Gravel; Form Graders; Bulk Cement Plant; Oilers; and Starting Engineer on Pipeline or Construction (3 - 5 pieces) including: Air Compressor (Trailer Mounted), All Forced Air Heaters (regardless of Size), Water Pumps (Greater than 4-1/2" or Total Discharge Over 4-1/2"), Light Plants, Generators (Trailer Mounted - Excluding Decontamination Trailer), Welding Machines (Any Size or Mode of Power), Conveyor, Mixer (any size), Stud Welder, Power Pac, etc., and Ground Heater (Trailer Mounted).

Other Classifications of Work:

For definitions of classifications not otherwise set out, the Department generally has on file such definitions which are available. If a task to be performed is not subject to one of the classifications of pay set out, the Department will upon being contacted state which neighboring county has such a classification and provide such rate, such rate being deemed to exist by reference in this document. If no neighboring county rate applies to the task, the Department shall undertake a special determination, such special determination being then deemed to have existed under this determination. If a project requires these, or any classification not listed, please contact IDOL at 217-782-1710 for wage rates or clarifications.

LANDSCAPING

Landscaping work falls under the existing classifications for laborer, operating engineer and truck driver. The work performed by landscape plantsman and landscape laborer is covered by the existing classification of laborer. The work performed by landscape operators (regardless of equipment used or its size) is covered by the classifications of operating engineer. The work performed by landscape truck drivers (regardless of size of truck driven) is covered by the classifications of truck driver.

SUBSTANCE ABUSE PREVENTION PROGRAM

Before the Contractor and any Subcontractor commences work, the Contractor and any Subcontractor shall have in place a written Substance Abuse Prevention Program for the prevention of substance abuse among its employees which meets or exceeds the requirements in P.A. 95-0635 or shall have a collective bargaining agreement in effect dealing with the subject matter of P.A. 95-0635.

The Contractor and any Subcontractor shall file with a public body: a copy of the substance abuse prevention program along with a cover letter certifying that their program meets the requirements of the Act, or a letter certifying that the Contractor or a Subcontractor has a collective bargaining agreement in effect dealing with the subject matter of the Act.

PROTECTION OF THE PUBLIC

In general, protection of the public shall be in accordance with Chapter 26, Article V of the Code of the City of Peoria, Illinois entitled "Excavation Generally," except that Sections 26-139, 26-140, 26-141 and 26-142 shall not apply.

Barricades, warning signs, and other devices shall be maintained as provided for by the City Code herein referred. The cost of any signs, barricades, or warning devices required to adequately accomplish partial or complete closure of streets shall be incidental to the item of work for which the traffic control is needed, and no additional compensation will be allowed.

ITEMS DESIGNATED FOR REMOVAL AND EXCAVATION

All removal items and excavated material remain the property of the Contractor unless otherwise indicated in the contract documents. The Contractor shall dispose of the removed items and/or excavated material outside the limits of the improvement as the Contractor may provide. Excavated material to remain on the job site shall be placed as directed by the Engineer.

CITY SIGNS

The contractor, at his own expense, shall be required, as directed by the Engineer, to relocate or remove and reinstall all street, traffic, parking, etc. signs belonging to the City within the limits of the improvement. All signs which interfere with construction operations shall be removed, stored in a place away from work, and replaced by the contractor after the improvement has been completed if they are not required for traffic control. Signs which are required for traffic control shall be reinstalled at a temporary location acceptable to the Engineer, in a workmanlike manner, visible to traffic, and maintained straight and neat for the duration of the temporary setting. Signs shall not be moved until progress of the work demands the relocation. The cost of this item shall be included in the contract unit price bid for the item of work which necessitated the removal.

DAMAGE TO EXISTING TREES

All necessary precautions shall be taken to prevent damage to existing trees. Roots of two inch (2") diameter or more shall not be severed. Precautions shall be taken to prevent damage to the bark of existing trees by machinery or other means. Any damage shall be corrected as directed by the Engineer at the expense of the Contractor.

SAWCUTTING

Sawcutting shall be required at all removal limits unless otherwise approved by the Engineer. This shall be considered incidental to the item of construction involved and no additional compensation will be allowed.

CONTACT PERSON

The City's Project Manager is Stephen Letsky, 309-494-8817. Any questions you may have in reference to any portion of the bidding process can be directed to Stephen. A Resident Engineer will be hired by the City to coordinate field operations. They will provide invoicing quantities and amounts to the Contractor after the completion of work on a monthly basis.

EQUAL OPPORTUNITY REQUIREMENTS

EEO CONTRACT COMPLIANCE CLAUSE

It is hereby declared to be the public policy of the City of Peoria, that it will not execute a contract for goods and/or services with any individual, business enterprise, supplier/vendor; maintain a financial relationship with any financial institution; or use the services of any labor organization or member thereof found to be in violation of the provisions of the Municipal Code for the City of Peoria, Chapter 17, Article III, Division 4, Section 17-118.

This clause covers contractors, vendors, suppliers, borrowers and/or recipients of city resources, purchasers and/or developers of city owned property, and any other individuals or entities providing goods and/or services to the City of Peoria; and are hereinafter referred to as "Contractor."

If any Contractor conducting business with the City of Peoria fails to comply with the fair employment and affirmative action provisions of Chapter 17, Article III, Division 4 of the municipal code (hereinafter Chapter 17), the city, at its option, may do any or all of the following:

- (1) Cancel, terminate, or suspend the contract in whole or in part;
- (2) Declare the contractor ineligible for further contracts for one calendar year;
- (3) The Fair Employment and Housing Commission (hereinafter FEHC), in accordance with its rules and regulations, shall have the power to impose a penalty upon any Contractor failing to comply with Chapter 17 in an amount not less than \$50.00; nor more than as provided in Chapter 1, Section 1-5 of the municipal code, for each day that the Contractor fails to comply, upon a specific finding of such violation. The FEHC may order a Contractor found guilty of failure to comply with the provisions of Chapter 17 to pay all or a portion of the legal costs incurred by the city as a result of prosecution of such violations. Penalties assessed under the this clause may be recovered from the Contractor by setoff against unpaid portion of the contract price; and
- (4) Such other sanctions as may be imposed by the FEHC pursuant to the provisions of Chapter 17 and other applicable ordinance provisions of the municipal code.

During the performance of this contract, the Contractor agrees:

- (A) That it will not discriminate against any employee or applicant for employment because of race, color, religion, sex, sexual harassment, ancestry, national origin, place of birth, age, or a physical and/or mental disability which would not interfere with the efficient performance of the job in question. The contractor/vendor will take affirmative action to comply with the provisions of Peoria City Code, Chapter 17 and will require any subcontractor to submit to the City of Peoria a written commitment to comply with this division. The Contractor will distribute copies of this commitment to all persons who participate in recruitment, screening, referral, and selection of job applicants, prospective job applicants, members, or prospective contractors.

The Contractor agrees that the provisions of Chapter 17, of the Municipal Code of the City of Peoria is hereby incorporated by reference, as if set out verbatim

- (B) That it will examine each one of its workforce job classifications to determine if minorities and/or females are underutilized; and it will take appropriate affirmative action steps to rectify such identified underutilization.
- (C) That if it hires additional employees in order to perform this contract or any portion thereof, it will determine the availability of minority and females in the area(s) from which it may reasonably recruit; and every good faith effort will be made in its selection process to minimize or eliminate identified areas of minority and/or female underutilization for each job classification for which there are employment opportunities.

EEO Contract Compliance Clause

Page 2

- (D) That during the performance of this contract, the Contractor will maintain its eligibility status to conduct business with the City of Peoria under the provisions of the EEO certification registration program.
- (E) That in all solicitations or advertisements for employees placed by it or on its behalf, it will state that all applicants will be afforded equal opportunity without discrimination because of race, color, sex, religion, national origin, age, or physical and/or mental disability.
- (F) That it will send to each labor organization or representative of workers with which it has or is bound by a collective bargaining agreement or understanding, a notice advising such labor organization or representative of the Contractor's obligations under Chapter 17. If any such labor organization or representative fails or refuses to cooperate with the Contractor in its efforts to comply with Chapter 17, the Contractor will promptly so notify the Equal Opportunity Office (hereinafter EEO) and/or the FEHC for the City of Peoria.
- (G) That it will submit reports as required and furnish all relevant information as may from time to time be requested the EEO and/or the FEHC.
- (H) That it will permit access to all relevant books, records, accounts and work sites by EEO staff members for purposes of investigation to ascertain compliance with Chapter 17.
- (I) That it will include verbatim or by reference the provisions of Section 17-120 of Chapter 17 so that such provisions will be binding in the same manner as with other provisions of this contract. The Contractor will be liable for compliance with applicable provisions of this clause by all its subcontractors; and further, it will promptly notify the EEO and/or FEHC in the event any subcontractor fails or refuses to comply therewith. In addition, no Contractor will utilize any subcontractor declared by the EEO and/or FEHC to be non-responsive and therefore, ineligible for contracts or subcontracts with the City of Peoria.
- (J) That during the performance of this contract, the Contractor agrees: that it will have written sexual harassment policies that shall include, at a minimum, the following information: (i) the illegality of sexual harassment; (ii) the definition of sexual harassment under state law; (iii) a description of sexual harassment utilizing examples; (iv) the contractor's internal complaint process including penalties; (v) the legal recourse, investigative and complaint process available through the Illinois Department of Human Rights and the Human Rights Commission; (vi) directions on how to contact the Department of Human Rights and the Commission; and (vii) protection against retaliation as provided by Section 6-101 of this Act (Public Act 87-1257). A copy of the policies shall be provided to the Illinois Department of Human Rights or the City of Peoria upon request.
- (K) That during the performance of this contract, the Contractor agrees that they do not and will not maintain or provide for their employees, any segregated facilities at any of their establishments, or permit employees to perform their services at any location under their control where segregated facilities are maintained.

As used in this document, the term segregated facilities means any waiting rooms, work areas, rest rooms and wash rooms, and other storage or dressing areas, parking lots, drinking fountains, recreation or entertainment areas, transportation, housing facilities provided for employees which are segregated by explicit directive or are in fact segregated on the basis of race, religion, color, national origin, because of habit, local custom, or otherwise.

(Revised 01/04)



MINORITY AND WOMEN'S BUSINESS ENTERPRISE (M/WBE) PARTICIPATION

REQUIREMENTS FOR GOOD-FAITH EFFORTS (Projects exceeding \$50,000)

Description of Program

- A. It is the policy of the City of Peoria to encourage participation of M/WBE's on all city-funded construction projects. In complying with this clause bidders are required, when subcontracting opportunities are available, to make a good-faith effort to meet the goals established for M/WBE participation. The participation goals are cited in Section VI on the Subcontractor Utilization Statement.
- B. Failure to submit the documentation requested in Sections II and III of this document may cause (1) the bid to be rejected and determined non-responsive; (2) subject the bidders to the sanctions described in Section VIII.

Pre-Bid Efforts when Awarding Subcontracts

- A. Bidders are required to contact and solicit, in writing, bids from M/WBEs for available subcontracting. In seeking solicitations, bidders are to identify the portion(s) of work to be subcontracted and offer to break down any portion(s) of work into economically feasible units in order to facilitate M/WBE participation. Bidders also are to provide the name of a specific contact person in their notice to the M/WBEs. Contact shall be made prior to bid opening. The name of each company contacted, the date and method must be submitted with bid documents.

The low bidder shall provide to the City of Peoria, upon request, copies of faxes, letters, and e-mails sent to M/WBEs

- B. Bidders who are a MBE or WBE are not exempt from soliciting bids for available subcontracting. The bidder is required to contact, in writing, firms that will help the bidder meet the participation goal for the targeted group opposite to which the bidder belongs. If the bidder is identified as both a MBE and WBE, the participation goals shall be deemed to have been met.

In seeking solicitations, bidders are to identify the portion(s) of work to be subcontracted and offer to break down any portion(s) of work into economically feasible units in order to facilitate M/WBE participation. Bidders also are to provide the name of a specific contact person in their notice to the M/WBEs. Contact shall be made prior to bid opening. A list containing the name of each company contacted, the date and method must be submitted with bid documents.

The low bidder shall provide to the City of Peoria, upon request, copies of faxes, letters, and e-mails sent to M/WBEs.

III. Good-Faith Efforts Documentation when Utilizing Subcontractors

- A. All Bidders must provide proof of its compliance with the pre-bid requirements and good-faith efforts to the City. Both the pre-bid documentation and the support documentation requested below must be submitted with bid documents.
 - 1. All Bidders must submit a properly completed “**Subcontractor Utilization Statement.**” All Bidders must provide the scope of work to be performed, the dollar amount to be paid, and the percentage amount of the contract for each company listed.
 - 2. All Bidders must submit a list of qualified M/WBE’s who submitted proposals but will not be utilized. This list must include a justification for not accepting the proposed bid.
- B. Disputes arising from the enforcement of these requirements will be resolved by the Equal Opportunity Office.

IV. Waiver Requirements When Self-Performing All Work

- A. All bidders will make every effort to make subcontract opportunities available to M/WBEs. However, if such an opportunity cannot be made available, the Bidder must seek a waiver by submitting “**M/WBE Participation Waiver Request.**” The waiver request must be submitted to the City of Peoria with bid documents.
- B. For the M/WBE waiver request to receive consideration, the following supportive documentation that applies must accompany the form:
 - 1. A narrative describing the Bidder’s good faith efforts to secure M/WBE participation prior to bid opening.
 - 2. A notarized affidavit attesting the Bidder did not receive inquiries or proposals from qualified M/WBEs in response to the required notification prior to bid opening.

3. A written explanation for why the Bidder believes no subcontracting opportunities exist. ***If the City of Peoria determines that the explanation is insufficient it reserves the right to halt the bid award process to request additional information from the Bidder. The Bidder will receive the request for information in writing.***
4. A written explanation for why the Bidder believes it is impracticable to award any subcontract(s) on the project in question. ***If the Equal Opportunity Office determines that the explanation is insufficient it reserves the right to halt the bid award process to request additional information from the Bidder. The Bidder will receive the request for information in writing.***

V. Change In Use of Subcontractors or Self-Performance Status

Before the General Contractor can deviate from utilizing any of the subcontractors listed on the Subcontractor Utilization Statement or its declared intent to self-perform, it must submit a completed **Notification of Change in Participation** form to the City of Peoria. Upon notification construction on the project may be delayed or halted until a review is conducted by the Equal Opportunity Office.

Regarding a self-performance change, if a subcontracting opportunity has been made available, the General Contractor must identify all good faith efforts made to meet the M/WBE participation goals, unless the change was due to an emergency.

VI. Procedures for Counting M/WBE Participation toward Goals (based upon Department of Transportation regulations)

- i. When an M/WBE participates in a contract, count only the value of the work actually performed by the M/WBE toward M/WBE participation goals.
 1. Count the entire amount of that portion of a construction contract (or other contract not covered by paragraph (i)(2) of this section) that is performed by the M/WBE's own forces. Include the cost of supplies and materials obtained by the M/WBE for the work of the contract including supplies purchased or equipment leased by the M/WBE (except supplies and equipment the M/WBE subcontractor purchases or leases from the prime contractor or its affiliate).
 2. Count the entire amount of fees or commissions performed by an M/WBE firm towards M/WBE goals if that firm provides the Apparent Low Bidder a bona fide professional, technical,

consultant, or managerial service or provides bonds or insurance specifically required in a City of Peoria contract.

3. If an M/WBE subcontracts a portion of its work to an M/WBE, 100% of the value of the subcontracted work may be counted toward the M/WBE goal, but any portion of the work the M/WBE subcontracts to a non-M/WBE does not count toward the M/WBE goal.
- ii. When an M/WBE participates in a joint venture on a City contract, only count the dollar value of the portion of the work that the M/WBE performs with its own forces toward M/WBE goals.
 - iii. Count expenditures to an M/WBE contractor toward M/WBE goals if, and only if, the M/WBE is performing a commercially useful function on that contract.
 1. An M/WBE performs a commercially useful function when it is responsible for performing, managing, and supervising its contracted work; moreover, with respect to materials and supplies used on the contract, it must also be responsible for negotiating its price, and purchasing and managing those supplies.
 2. An M/WBE does not perform a commercially useful function if its role is limited to that of an extra participant in a transaction, contract, or project through which funds are passed in order to obtain the appearance of M/WBE participation. It should be noted that an effort contrived to give the appearance of M/WBE participation is not considered a good faith effort and is considered an ethical violation that is subject to sanctions outlined in section V.
 3. If an M/WBE does not perform or exercise responsibility for at least 30% of the total cost of its contract with its own work force, you must presume that it is not performing a commercially useful function and the dollar amount of that work will not count toward the M/WBE goals.
 4. When an M/WBE is presumed the City of Peoria not to be performing a commercially useful function as provided in paragraph (iii)(3) of this section, the M/WBE may present evidence to rebut this presumption. Your rebuttal is subject to review by the City of Peoria.

iv. Use the following factors in determining if an M/WBE trucking company is performing a commercially useful function:

1. The M/WBE trucking company must manage and supervise the trucking work it is being paid to perform. A contrived arrangement for the purpose of giving the appearance of meeting M/WBE goals is not considered a good faith effort.
2. The M/WBE trucking company must own and operate at least one fully licensed, insured, and operational truck used on the contract.
3. The M/WBE trucking company receives credit for the total dollar value of the transportation services it provides on the contract using trucks it owns, insures, and operates.
4. The M/WBE trucking company may lease trucks from another M/WBE trucking firm, including an owner-operator who is certified as an M/WBE. The M/WBE who leases trucks from another M/WBE receives total credit for the dollar value of the transportation services the M/WBE trucking lessee provides on the contract.
5. The M/WBE trucking company may also lease trucks from a non-M/WBE trucking firm, including an owner-operator. The M/WBE who leases trucks from a non-M/WBE is only entitled to credit for the fee or commission it receives as a result of the lease arrangement. The M/WBE does not receive credit for the total dollar value of the transportation services provided by the lessee since these services are not provided by an M/WBE.
6. A lease agreement with an M/WBE trucking firm must indicate that the M/WBE has exclusive use of and control over the truck. This does not preclude the leased truck from working for others during the term of the lease with the consent of the M/WBE, so long as the lease gives the M/WBE absolute priority for use of the leased truck. Leased trucks must display the name and identification number of the M/WBE.

v. Count expenditures with M/WBEs for materials and supplies toward M/WBE goals in the following manner:

1. If the materials or supplies are obtained from an M/WBE manufacturer, count 100% of the cost of the materials or supplies toward M/WBE goals.

Note: For purposes of this paragraph (v)(1), a manufacturer is a firm that operates or maintains a factory or establishment that produces, on the premises, the materials, supplies, articles, or equipment required under the contract and of the general character described by the specifications.

2. If the materials or supplies are purchased from an M/WBE regular dealer, count 60% of the cost of the materials or supplies toward M/WBE goals.

Note: For purposes of this section, a regular dealer is a firm that owns, operates or maintains a store, warehouse, or other establishment in which the materials, supplies, articles or equipment of the general character described by the specifications and required under the contract are brought, kept in stock, and regularly sold or leased to the public in the usual course of business.

(A) To be a regular dealer, the firm must be an established, regular business that engages, as its principal business and under its own name, in the purchase and sale or lease of the products in question.

(B) A person may be a regular dealer in such bulk items as petroleum products, steel, cement, gravel, stone, or asphalt without owning, operating, or maintaining a place of business as provided in this paragraph (v)(2), if the person both owns and operates distribution equipment for the products. Any supplementing of regular dealers' own distribution equipment shall be by a long-term lease agreement and not on an ad hoc or contract-by-contract basis.

(C) Packagers, brokers, manufacturers' representatives, or other persons who arrange or expedite transactions are not regular dealers within the meaning of the paragraph (v)(2).

3. If materials or supplies are purchased from an M/WBE which is neither a manufacturer nor a regular dealer, count only 5% of the contract amount toward the M/WBE goals.

VII. Record Keeping and Reporting

- A. The General Contractor and subcontractors agree to maintain records demonstrative of its good faith efforts to comply with the participation goals attached to the project. This would include, but not limited to, names of M/WBEs and non-minority firms awarded subcontracts, including dollar amount of the contract, payments to subcontractors, and weekly certified payroll reports. These records shall be made available to the City of Peoria.

- B. All information will be provided through ePrismSoft, an electronic web based compliance tracking software. Access to ePrismSoft has been furnished by the City of Peoria. To activate access, the General Contractor and subcontractors must contact Human Capital Development at webnfo@eprismsoft.com or 309/692-6400.

VIII. Sanctions

- A. The Equal Opportunity Office may recommend the rejection of the apparent low bid where the information submitted by the Apparent Low Bidder fails to objectively demonstrate compliance with the M/WBE Good-Faith Efforts requirements. The Apparent Low Bidder will be notified of this decision and the reasons in writing. The Apparent Low Bidder may request a hearing within five (5) business days of this notice. The request must be submitted to the Equal Opportunity Office. The hearing will be held no later than seven (7) business days after receipt of request. The City Manager or designee will conduct all hearings.
- B. Upon a finding that any party has not complied with the provisions of this clause, any one or a combination of the following actions may be taken:
 - 1. Declare the Apparent Low Bidder non-responsive and therefore ineligible for contract award.
 - 2. Declare the Apparent Low Bidder ineligible for further contracts for a calendar year.
 - 3. File a formal complaint against Apparent Low Bidder, and/or subcontractor with the Fair Employment and Housing Commission.

org. 05/08/08
rev. 04/17/12

HUMAN RIGHTS ACT

The contract will be subject to and governed by the rules and regulations of the Illinois Human Rights Act, including Public Act 87-1257 (effective July 1, 1993) which requires that every bidder shall have a written sexual harassment policy that includes, at a minimum, the following information:

- a. The illegality of sexual harassment;
- b. The definition of sexual harassment under State law;
- c. A description of sexual harassment, utilizing examples;
- d. The bidder's internal complaint process including penalties;
- e. The legal recourse, investigative and complaint process available through the Illinois Department of Human Rights and the Illinois Human Rights Commission;
- f. Directions on how to contact the Department and the Commission;
- g. Protection against retaliation as provided in the Act.

Bidders are hereby placed on notice, a copy of its policy shall be provided to the Department upon request.

SAXI-93
effective 7-1-93
per Legal Dept.

ROADWORK SPECIAL PROVISIONS

SALVAGING EXISTING MATERIAL

All existing municipally owned street castings, millings and pavement brick, in usable condition within the limits of the improvement shall, if not required for further use in the construction of the improvement, be carefully excavated and preserved by the Contractor. Sidewalk brick shall not be considered pavement brick and the contractor will have the salvage rights to the sidewalk brick removed. Said street castings, millings, and pavement brick shall be separated from other removal materials and hauled by the Contractor to the City's yard on Darst Street. The Contractor shall contact Sie Maroon at 309-654-5139, in advance of hauling salvaged materials to the City's yard on Darst Street.

The cost of salvaging and hauling existing municipally owned street castings, millings and pavement brick, as outlined herein, will not be paid for separately, but the cost shall be included in the contract unit price for the item of construction involved.

CONSTRUCTION DEBRIS

In accordance with Public Act 90-761, the following shall be added to the third paragraph of Article 202.03 of the "Standard Specifications for Road and Bridge Construction":

The Contractor shall not conduct any generation, transportation, or recycling of construction or demolition debris, clean or general or uncontaminated soil generated during construction, remodeling, repair, and demolition of utilities, structures, and roads that is not commingled with any waste, without the maintenance of documentation identifying the hauler, generator, place of origin of the debris or soil, the weight or volume of the debris or soil, and the location, owner, and operator of the facility where the debris or soil was transferred, disposed, recycled or treated. This documentation must be maintained by the Contractor for 3 years.

This documentation shall be included in applicable item of construction and shall not be paid for separately.

EROSION CONTROL

The Contractor shall install erosion control systems as necessary or as directed by the Engineer to prevent sediment from entering the City's storm drainage system or exiting the construction area. Erosion control systems shall be installed as necessary or as directed by the Engineer prior to stockpiling of material on the project site. The Contractor shall be responsible for the cost of cleanup and damages resulting from failure to comply with this provision. This work shall be considered incidental to the affected items of work and no additional compensation will be allowed.

The Contractor shall sweep and return to the work site any soil tracked onto the street by the end of the workday or before four (4) hours has elapsed, whichever is sooner. This work shall be considered incidental to the affected items of work and no additional compensation will be allowed.

TRENCH BACKFILL

This item shall conform to Section 208 and 1003 of the Standard Specifications except as follows:

Article 208.04 Basis of Payment. This item shall be paid for at the contract unit price per ton for Trench Backfill, measured as specified.

INLETS, TYPE G-1 (SPECIAL)

This work shall consist of furnishing all labor, equipment, and material for the construction and installation of a G-1 Inlet on a modified box in accordance with Section 602 of the Standard Specifications and as detailed on the drawings, except as modified herein. Pay item shall include the cost of a new apron to be constructed.

This work will be paid for at the contract unit price per EACH for INLETS TYPE G-1 (SPECIAL).

TRAFFIC CONTROL & PROTECTION

Traffic control shall be in accordance with the applicable sections of the "Standard Specifications for Road and Bridge Construction," the applicable guidelines contained in the "Manual on Uniform Traffic Control Devices for Streets and Highways," these special provisions, and any special details and Highway standards contained herein and in the plans.

Special attention is called to Articles 107.09 and 107.14 of the "Standard Specifications for Road and Bridge Construction," applicable "Recurring Supplemental Specifications and Special Provisions" and the following Highway Standards relating to traffic control:

(701301-04; 701501-06; 701502-06; 701601-09; 701602-07; 701606-09; 701701-09; 701801-05; and 701901-03)

When construction operations require the closure of one lane, except turn lanes, the closure of said lane shall require the use of the specified arrow board per Standard 701901-03. The work shall be performed as directed by the Engineer.

Traffic movement should be inhibited as little as practical. Motorists should be guided in a clear and positive manner while approaching and traversing construction work areas. To ensure acceptable levels of operation, routine inspection of traffic control elements should be performed. The contractor will be required to inspect and initiate any needed maintenance to the traffic control devices on this contract. All traffic control devices shall be removed immediately when no longer needed. Construction equipment, materials and debris should be stored in such a manner as to not be vulnerable to vehicle impact, as directed by the Engineer.

The Contractor is expected to maintain a minimum of one lane open to traffic at all times for traffic. The roadway may be closed for short periods in order to offload materials. However, this operation must take place with proper traffic control signage and/or flagmen as noted in the traffic control standards contained herein. Roadway closures, regardless of duration must be coordinated with City of Peoria Police and Fire Departments. It is absolutely necessary that one lane of roadway can be used by fire, police, and other emergency vehicles at all times under all weather conditions.

The contractor shall, at all times, maintain a means for sidewalk traffic to detour the job. He shall also provide a minimum of interference to vehicular traffic and shall maintain barricades and warning signs as provided by the "Standard Specifications for Road and Bridge Construction."

The Contractor will be responsible for scheduling his operations to provide access to all businesses located along the improvement that have current access to the street. No less than one entrance to each commercial parking lot or building shall remain open at all times during construction.

The Contractor will be responsible with scheduling garbage pick up in the neighborhood along with notifying in writing no less than 3 calendar days before removing any part of existing alleys or driveways.

Non-Conformance: If the Contractor fails to comply with the above conditions, the Engineer may suspend the Contractor's work until the Contractor is in compliance with the above conditions.

TRAFFIC CONTROL AND PROTECTION will be paid for on a LUMP SUM basis.

BEAVER DAMS

This item of work shall consist of providing and installing Beaver Dams as indicated on the plans and as suggested by the Engineer. This work shall also be done in accordance with the applicable portions of Section 280 of the Standard Specifications and as directed by the Engineer.

Inlets that may receive runoff from the construction site shall be protected with the "Beaver Dam", as provided by MIRAFI, or approved equal. Additionally, once the pavement is constructed and grading and shaping work starts behind the new curb and gutter, all newly constructed inlets shall be protected with the "Beaver Dam". Said protection shall remain in place until the sod has been placed and the Engineer allows removal.

All erosion control items shall be properly maintained by the Contractor, as recommended by the manufacturer and as suggested by the Engineer.

This work will be paid for at the contract unit price bid per EACH for BEAVER DAMS, which shall include all labor, tools, materials and equipment necessary to complete and maintain this work as specified.

INLET MANHOLES, TYPE G-1, 4' DIA., (SPECIAL)

This work shall consist of furnishing all labor, equipment, and material for the installation of Inlet Manholes, Type G-1, 4' Dia., (Special), in accordance with Section 602 of the Standard Specifications.

This work will be paid for at the contract unit price per EACH for INLET MANHOLES, TYPE G-1, 4' DIA., (SPECIAL)

INLET MANHOLES, TYPE G-1, (SPECIAL)

This work shall consist of furnishing all labor, equipment, and material for the installation of Inlet Manholes, Type G-1, 4' Dia., (Special), in accordance with Section 602 of the Standard Specifications.

This work will be paid for at the contract unit price per EACH for INLET MANHOLES, TYPE G-1, (SPECIAL)

AGGREGATE BASE COURSE, TYPE CS-01

This work shall consist of furnishing all labor, equipment, and material for the installation of Aggregate Base Course, Type CS-01, in accordance with Section 303 of the Standard Specifications, except as modified by attached BDE Special Provision "Aggregate Subgrade Improvement" and as modified herein. The coarse aggregate gradation shall be CS-01.

This work will be paid for at the contract unit price per TON for AGGREGATE BASE COURSE, TYPE CS-01.

AGGREGATE BASE COURSE, TYPE B, CA-6

This work shall consist of furnishing all labor, equipment, and material for the installation of Aggregate Base Course, Type CA- 6, in accordance with Section 351 of the Standard Specifications, except as modified herein.

This work will be paid for at the contract unit price per TON for AGGREGATE BASE COURSE, TYPE CA-6.

TEMPORARY MAILBOX RELOCATION

This item of work consists of temporarily relocating 23 mailboxes along Columbine Drive to two locations. Contractor has the option of using the existing mailboxes or providing others. Contractor shall also provide appropriate house numbers on the mailboxes. Prior to installing the temporary mailboxes, the Contractor shall contact the U.S. Post Office in Peoria for approval of the temporary location.

After the project is completed, the Contractor shall reinstall mailboxes at either the original location or a location approved by the Engineer.

Payment for this item shall be at the contract unit price per lump sum for Mailbox Relocation, which price shall include all labor, equipment and materials necessary.

UNDERCUTTING SUBBASE

This item shall be done in accordance with Section 202 of the Standard Specifications and shall only be done after being approved by the Engineer. The Contractor must first satisfy the Engineer that he has made every effort to stabilize the subgrade in accordance with the methods outlined in Article 301.03 before requesting approval to proceed with any subgrade replacement. Contractor must use the appropriate type of equipment to process the subgrade, as specified in Article 301.04(b) of the Standard Specifications.

At the locations approved by the Engineer for subgrade removal, this item shall be paid for at the contract unit price per CUBIC YARD for UNDERCUTTING SUBBASE.

GEOTECHNICAL FABRIC FOR BASE REPAIR

This item shall be done in accordance with the applicable portions of Section 210 of the Standard Specifications. The work shall include the furnishing and installing the fabric on the subgrade at locations designated by the Engineer. This item has been provided in the event some areas in the subgrade require stabilization. This item shall be paid for at the contract unit price per square yard for Geotechnical Fabric for Base Repair. The granular blanket for this item shall be Aggregate Base Course, CA-6.

The Geotechnical Fabric shall be a woven fabric, equal to Amoco 2006, TNS W300, LINQ GTF 300, SYNTHETIC INDUSTRIES GEOTEX 315ST or TC MIRAFI 600X, and shall meet the following requirements:

<u>Physical Property</u>	<u>Value</u>
Grab Tensile Strength (lbs) – ASTM D 4632	300
Grab Elongation @ Break (%) – ASTM D 4632	15
Burst Strength (psi) – ASTM D751	600
Trapezoidal Tear Strength (lbs) – ASTM D 4533	120
Water Flow Rate (GPM/SF) – ASTM D 4491	4

Above values to be minimum average roll values. If unusual or abnormal conditions exist, a different fabric may be required, as **suggested** by the Engineer. If a different fabric is required, a cost adjustment may be considered. Prior to installation, the Contractor shall submit, to the Engineer, a Physical Property Sheet for the type of fabric he or she intends to use.

P.C.C. DRIVEWAY PAVEMENT, 6”

This work shall consist of constructing a 6” P.C.C. driveway pavement as directed by the Engineer. Provisions shall be made for satisfactory transition between the proposed driveway pavement and the existing pavement to remain in place. This work shall be in accordance with applicable portions of Section 423 of the “Standard Specifications for Road and Bridge Construction.”

The method of measurement shall be the total exposed surface area of the driveway in square yards for each property.

This work shall be paid for at the contract unit price per SQUARE YARD of P.C.C. DRIVEWAY PAVEMENT, 6”, which shall include all labor, earth backfill, granular backfill, materials, curing compound, tools and equipment necessary to complete this work as specified.

P.C.C. SIDEWALK, 4”

This work will be performed in accordance with Section 424 of the “Standard Specifications for Road and Bridge Construction” and City Standards.

The method of measurement shall be the total exposed surface area of the walk in square feet for each property.

This work will be paid for at the contract unit price bid per SQUARE FOOT for P.C.C. SIDEWALK, 4"., which shall include all labor, curing compound, tools and equipment necessary to complete this work as specified.

TREE REMOVAL AND RELOCATION

This work will be performed in accordance with Section 253 of the "Standard Specifications for Road and Bridge Construction" and City Standards.

Two trees shall be relocated from within the right of way. The trees shall be relocated using a tree spade as directed by the engineer.

This work will be paid for at the contract unit price bid per EACH for TREE REMOVAL AND RELOCATION, which shall include all labor, tools and equipment necessary to complete this work as specified.

DETECTABLE WARNINGS

This work shall consist of a 24-inch strip of the Federal Standard color 30166, brick red, as its standard of detectable warning in the direction of travel and shall extend the full width of the curb ramp or flush surface. This work shall conform to the details given in the plans and in accordance with Section 424 of the "Standard Specifications for Road and Bridge Construction".

Detectable warnings shall be installed at all designated ADA ramps per the appropriate IDOT curb ramp standard.

The following will be the acceptable construction techniques.

1. Cast-in-Place truncated dome ramps must be formed with a rigid mold. Every area of the tool shall be tamped directly above the stamp to form a uniform appearance. The concrete used shall be Class X (SI) concrete that has the Federal Standard color 30166, brick red, the entire depth. Broadcasting brick red dye or painting the sidewalk brick red **will not** be acceptable methods.
2. DetecTile PFC Composite truncated dome panels. Panels must be the Federal Standard color 22144, brick red. Panels shall be placed within the Class X (SI) concrete. They shall have a minimum of four anchors per ceramic panel to secure the panels to the concrete ramp.
3. Armor-Tile Tactile Systems manufactured Diamond-Hard Vitrified Polymer truncated panels. Panels must be the Federal standard color 22144, brick red.
4. Pre-Cast concrete truncated dome ramp panels. The panels shall be a minimum of 2-inches thick with the entire depth consisting of Class X (SI) concrete that is Federal Standard color 22144, brick red. The pre-cast panels shall have wire mesh or fiber mesh reinforcement. Tapered edges or holes so that dowel reinforcement rod can be placed within the insert shall be acceptable methods. These shall be placed before placing the rest of the ramp so that they are tightly secured into place.

Final determination of acceptability shall be the responsibility of the construction engineer.

THESE FOUR METHODS ARE THE ONLY ACCEPTABLE MEANS FOR TRUNCATED DOME RAMPS WITHIN THE CITY OF PEORIA.

Detectable Warnings will be paid for at the contract unit price per square foot of surfacing, which shall include all labor, tools, materials and equipment necessary to complete the work as specified.

DRIVEWAY PAVEMENT REMOVAL, PAVEMENT REMOVAL

This work shall consist of the removal of all driveway pavement and other pavements as directed by the Engineer. This work shall be done in accordance with Section 440 of the "Standard Specifications for Road and Bridge Construction." Payment for removal and replacement will not be allowed for items removed beyond the limits of construction or those items damaged needlessly by the contractor. The cost of sawing pavement where noted or directed by the engineer shall be incidental to the item of work.

This work will be paid for at the contract unit price per SQUARE YARD for DRIVEWAY PAVEMENT REMOVAL and PAVEMENT REMOVAL; which shall include saw cutting, removing and disposing of said structure, all labor, tools, materials and equipment necessary to complete this work as specified.

COMBINATION CURB AND SIDEWALK REMOVAL, SIDEWALK REMOVAL

This work shall consist of the removal of all combination curb/sidewalk and sidewalk as directed by the Engineer. This work shall be done in accordance with Section 440 of the "Standard Specifications for Road and Bridge Construction." Payment for removal and replacement will not be allowed for items removed beyond the limits of construction or those items damaged needlessly by the contractor. The cost of sawing pavement where noted or directed by the engineer shall be incidental to the item of work.

The basis of payment shall be the area in square feet of the top surface of the curb and sidewalk for each property and will not include the front finished face of curb.

This work will be paid for at the contract unit price per SQUARE FOOT for SIDEWALK REMOVAL and COMBINATION CURB AND SIDEWALK REMOVAL; which shall include saw cutting, removing and disposing of said structure, all labor, tools, materials and equipment necessary to complete this work as specified.

CURING COMPOUND

This item shall be furnished and applied in accordance with Article 1020.13 of the "Standard Specifications" except as herein provided. Curing Compound shall be applied to all exposed Portland Cement Concrete Surfaces.

This work will not be paid for separately but shall be included in the cost of the item of the construction bid.

CONCRETE FIBERS

The contractor may use micro-fibers in lieu of the welded wire mesh. The micro-fibers and dosage rate shall be approved by the engineer prior to use. The dosage rate shall meet the recommendations of the supplier. The micro-fibers shall be supplied by an IDOT approved supplier of synthetic fibers. Concrete fibers will not be paid for separately but shall be included in the cost of the concrete item.

SIDEWALK RAMPS FOR THE DISABLED

Sidewalk ramps shall be constructed per ADA requirement. Details of ramps are per Highway Standard 424001-07, 424006-01, 424011-01, 424016-02, 424021-01, 424026-01, and 424031-01. Any variation in the shape of curbs and sidewalk or needed landscaping of dirt at a corner to accommodate ramps for the handicapped shall not be paid for separately, but shall be considered incidental to the item of construction involved.

This work will be paid for at the contract unit price per SQUARE FOOT of P.C.C. COMBINATION CURB & SIDEWALK, 4" or P.C.C. SIDEWALK 4".

Any side curb poured integrally with a ramp will be paid for at the contract unit price per SQUARE FOOT OF P.C.C. COMBINATION CURB & SIDEWALK 4"; The square footage will not include the exposed vertical surface areas of the side curbs.

Detectable warnings will be paid for at the contract unit price per SQUARE FOOT. There shall be a minimum of four inches of concrete placed below the panels.

TIE BARS & DOWEL BARS

All tie bars required for sidewalk, curb, or pavement will not be paid for separately but included in the cost of the item the tie bars are required for. Any dowel bars required will not be paid for separately but included in the cost of the item required for.

RECTANGULAR RAPID FLASHING BEACON WITH TYPE A CONCRETE BASE

This work shall consist of installing a PAIR of Pedestrian activated, wireless communicative, Solar powered, Rectangular Rapid Flashing Beacons with Type A concrete foundations and all electrical components incidental to the complete installation. The item shall be manufactured and assembled by TAPCO (Catalog #RRFB-XL2-NA1) or with equivalent by Engineer's Approval. This assembly shall include wireless communication, signs, LED light bars, RRFB Controllers, Solar Panel, Battery, Bulldog Push Button, PPB signs, W11-2 signs, W16-7P(R&L) signs, cables, all brackets and mounting hardware, and 13' Aluminum poles (per TAPCO Package #101919-18 or equivalent per Engineer's Approval).

Basis of Payment: This work will be paid for at the contract unit price per PAIR for RECTANGULAR RAPID FLASHING BEACON WITH TYPE A CONCRETE BASE. This work shall include in full all labor, equipment, foundations, poles, push buttons, signs, and electrical components required to provide and install the SP RRFB as described above.

APPENDIX A

EEO DOCUMENTS

READ THIS PAGE BEFORE FILLING OUT THE EMPLOYER REPORT CC-1 OR THE RENEWAL APPLICATION

This page outlines the instructions you need to follow to process either the Employer Report Form CC-1 or the Renewal Application. Forms that are not filled out properly will not be processed.

Processing Fee: Effective January 1st, 2006, in accordance with recent changes to chapter 17 of the Peoria Municipal Code, a fifty-dollar (\$50.00) processing fee will be charged with each submission of the Employer Report Form CC-1 and the Renewal Application. The only exception to payment of the processing fee is neighborhood associations.

Method of Processing Fee Payment: The City of Peoria Treasurer's office will only accept check, money order, and cash payment. Make checks payable to the "City of Peoria".

Who needs to fill out the Employer Report Form CC-1 or the Renewal Application? Any business providing a good or service to the City for remuneration or any business receiving financial assistance from the City.

Under what legal authority does the City of Peoria require this application? The filing requirement is authorized under chapter 17, Peoria Municipal Code, section 17-120(b).

Which form do I submit?

Employer Report Form CC-1: If your company has not received an EEO Certification Number from the City of Peoria, you need to complete the Employer Report Form CC-1. You will also need to submit a copy of your company's **Sexual Harassment Policy** (for specific instructions on the sexual harassment policy, see the Sexual Harassment Policy Information Sheet).

Renewal Application: If your company currently has an EEO Certification Number from the City of Peoria that has expired, or is about to expire, you only need to complete the Renewal Application form. If you are submitting the Renewal Application you do not need submit the Sexual Harassment Policy as it is already on file.

Submittal Instructions: Either **mail** or **hand deliver** your completed materials.

Mail: Mail forms and payment to the Office of Equal Opportunity. The EO Office will review the forms. If they are complete and correct, the EO Office will process your forms and mail, fax, or email you a copy of your EEO certificate. Send forms and payment to:

City of Peoria
Office of Equal Opportunity
419 Fulton Street, Room 303
Peoria, IL 61602-1276

Hand Delivery: If you choose to hand deliver your forms and payment, you must first go to the Office of Equal Opportunity (address listed above). The EO Office will review your form for completeness and then ask you to stop by the Treasurer's Office, City Hall Building, Room 100 to make your Processing Fee payment. The EO office will process your forms and mail, fax, or email you a copy of your EEO certificate.

If you have any questions, call the Equal Opportunity Office at (309) 494-8530

KEEP THIS PAGE FOR YOUR RECORDS

MINORITY AND WOMEN BUSINESS ENTERPRISE DIRECTORY

To assist Bidders in their outreach efforts, the City of Peoria has developed a Minority and Women Business Enterprise (M/WBE) directory. Go to the City's website at <http://www.peoriagov.org/equal-opportunity/minority-and-women-business-enterprise-mwbe-directory/> to view the directory.

EQUAL EMPLOYMENT OPPORTUNITY

To be awarded a contract all Suppliers, Vendors and Contractors to the City of Peoria must be registered in the City of Peoria's Contract Compliance Program and have a current EEO Certification Number. This program is unrelated to any State or Federal program. To obtain or renew a number, an Employer Report Form CC-1, a copy of your company's sexual harassment policy statement, if a first time applicant and a Fifty-dollar (\$50.00) processing fee must be submitted to the City of Peoria. Go to the City's website at <http://www.peoriagov.org/equal-opportunity/> to obtain the form and instructions page.

Note: Suppliers, Vendors and Contractors do not need an EEO Certification Number to submit a bid proposal. However, it is required prior to the award of the contract.

MINORITY AND FEMALE WORKFORCE UTILIZATION

The City of Peoria is committed to ensuring our construction projects offer equal employment opportunity to all the citizens we serve. The Prime Contractor and all of its subcontractors are to make a good faith effort to comply with the following goals for minority and female workforce utilization.

1. Eighteen (18) percent of the total hours worked, per trade, should be performed by minority workers.
2. Three (3) percent of the total hours worked, per trade, should be performed by female workers.

Each contractor must maintain certified payroll records verifying the hours worked by minority and female workers. These records must be provided to the City of Peoria. For directions on submitting this information, see Minority and Women's Business Enterprise (M/WBE) Participation Requirements for Good-Faith Efforts, Section VII.

CONTRACT DELIVERABLES

CITY OF PEORIA SUBCONTRACTOR PAYMENT FORM

PRIME CONTRACTOR

PROJECT

Name: _____
 Address: _____
 Phone: _____
 Contact Person: _____

Name: _____
 Pay Estimate No: _____
 Percent Complete: _____ %
 Work Period: _____ to _____

INSTRUCTIONS: Complete the table below. If additional space is needed attach extra pages as needed and included all information listed in the table below; along with project name and prime contractor.

Subcontractor (Name)	Payment Amount	Payment Type (F-full/ P-partial)
	\$	
	\$	
	\$	
	\$	
	\$	
	\$	
	\$	
Total Payment Amount for Work Completed	\$	

This form is to verify the work completed and the amount paid to a subcontractor utilized on the above listed project. Under penalty of law for perjury or falsification, the undersigned certifies that the payment reported herein was made to the subcontractors listed.

 Signature of Prime Contractor

 Date

CITY OF PEORIA MONTHLY WORKFORCE ANALYSIS

Check appropriate status

Month Ending _____

Contractor
 Subcontractor

Name: _____

Address: _____

Contact Person: _____ Phone: _____

Project: _____

Date Work Started: _____ Percent Complete: _____%

Job Categories	Number of Employees				Hours of Employment									
	Total # of Employees		Total Minorities		African American		Asian/Pacific Islander		American Indian/Alaskan Native		Hispanic		White	
	M	F	M	F	M	F	M	F	M	F	M	F	M	F
Foremen														
Electricians														
Glaziers														
Iron Workers														
Laborers														
Teamsters														
Millwrights														
Pipe Fitters														
Plumbers														
Plasterers														
Painters														
Roofers														
Operating Engs														
Tile Layers														
Sheet Metal Wkrs														
TOTALS														

Instructions: The total number of hours worked on the project (Hours of Employment), and the total number of individuals working on the project during the reporting period (Number of Employees) should be submitted on this form to the Project Resident Engineer every month. Each contractor and subcontractor should submit with this form certified payroll records for the period covered. The prime contractor is responsible for securing and submitting with his/her report, reports from all subcontractors.

**CITY OF PEORIA
NOTIFICATION OF CHANGE IN PARTICIPATION**

Type of Change _____

Date: _____

_____ Subcontractor. Complete Part 1
_____ Self-Performance. Complete Part 2

PRIME CONTRACTOR

PROJECT

Name: _____
Address: _____
Phone: _____

Name: _____

PART 1

If changing from previously identified subcontractor to another, complete both From and To.

From Name _____
Address _____

Phone _____
Status _____ MBE _____ WBE _____ Non-M/WBE

To Name _____
Address _____

Phone _____
Status _____ MBE _____ WBE _____ Non-M/WBE
Contract Amount _____

Will scope of work change? _____ Yes _____ No
Describe change _____

Reason for Contractor Change _____

PART 2

Complete if deviating from intent to self-perform.

Prime Contractor will have to hire another contractor to perform work. _____ Yes _____ No

Change was due to _____ Emergency _____ Non-Emergency
Explain Situation _____

Describe good faith efforts to utilize M/WBE _____

Name of added Contractor _____
Address _____

Phone _____
Status _____ MBE _____ WBE _____ Non-M/WBE
Scope of Work _____

Contract Amount _____

Signed: _____
Contractor

Title

MISCELLANEOUS

CITY OF PEORIA
CONTRACT

This agreement, made and entered into this _____ day of _____, 2016, by and between the City of Peoria, an Illinois Municipal Corporation, Party of The First Part, and _____, Party of The Second Part for the improvement known as the _____;

WITNESSETH: That for and in consideration of the payments and agreements mentioned in the proposal hereto attached, to be made and performed by the Party of the First Part, and according to the terms expressed in the bond referring to these presents, the Party of The Second Part agrees with said Party of The First Part, at his/their own proper cost and expense to furnish and deliver all the work, materials and supplies in accordance with the specifications contained in said proposal, and in full compliance with all the terms of this agreement, for the amount of _____ (\$_____).

IT IS UNDERSTOOD AND AGREED that the instructions to bidders, proposal, bid, specifications, performance bond and maintenance bond are component parts of this contract and shall be deemed a part hereof. It is also understood and agreed that the contractor shall not assign, transfer, convey or otherwise dispose of this contract, or his right to execute it, or his right, title or interest in or to it or any part thereof, unless the previous written consent of the City Manager of the City of Peoria shall first be obtained thereto.

EMPLOYEE/EMPLOYMENT RESTRICTIONS – THE CONTRACTOR:

THE CONTRACTOR (hereinafter referred to as "SERVICE PROVIDER") agrees, as a condition of accepting this contract with the City of Peoria, that, for a period of one (1) year following completion of this contract, it shall be prohibited from hiring, directly or indirectly, any City employee or official who was involved, directly or indirectly in: (1) the selection and/or recommendation to select the SERVICE PROVIDER for performance of this contract; (2) coordinating the efforts of the SERVICE PROVIDER in the consummation or completion of this contract; or (3) monitoring or determining the performance of the SERVICE PROVIDER. The SERVICE PROVIDER further acknowledges and agrees that, upon the City's determination that a violation of this provision has occurred, the penalty imposed, at the sole discretion of the City, may include one or more of the following: (1) cancellation of any other contract(s) between the City of Peoria and the SERVICE PROVIDER; (2) disqualification of the SERVICE PROVIDER from bidding or being awarded future contracts with the City of Peoria for a period of two years; and/or (3) payment of liquidated damages to the City of Peoria in the amount of TWENTY FIVE THOUSAND DOLLARS (\$25,000.00).

IN WITNESS WHEREOF, the said parties have executed these presents on the date above mentioned.

THE CITY OF PEORIA

BY: _____
City Manager

ATTEST: _____
City Clerk

EXAMINED AND APPROVED:

Corporation Counsel

PARTY OF THE SECOND PART

(name of individual, firm, or corporation)

BY: _____
(member of firm or officer of corporation)

(If a Co-Partnership)

(seal) (seal)

Partners doing business under the firm name
of _____ (seal)
(Party of the second part)
(If an Individual)

(seal)

(Party of the second part)

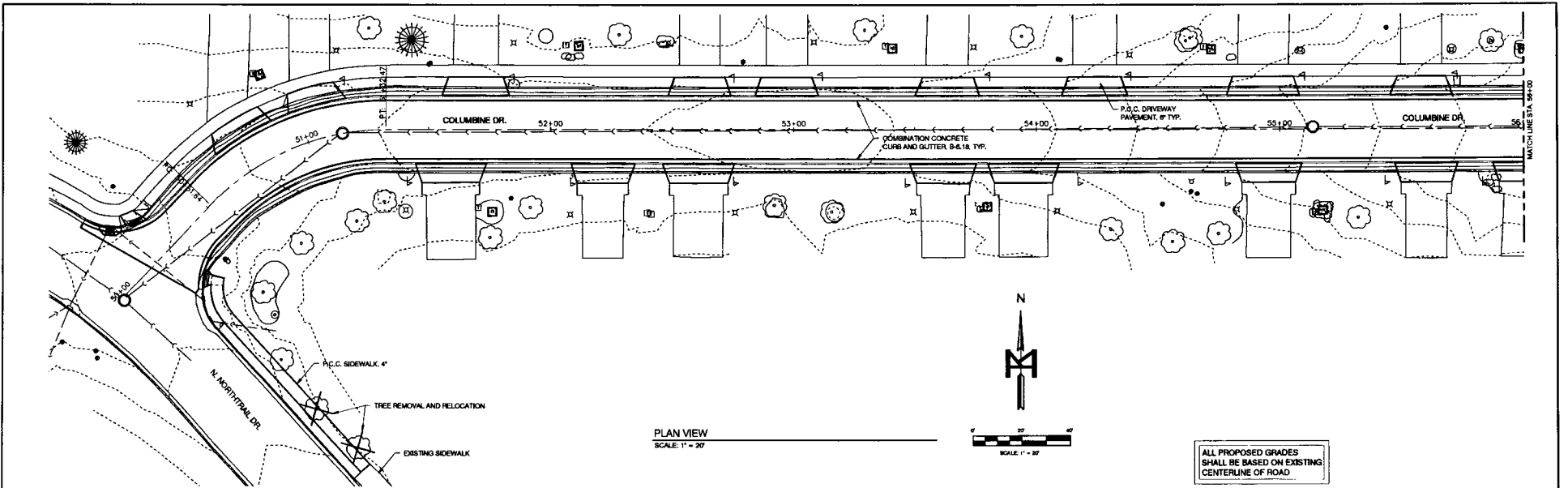

PLAN VIEW
SCALE: 1" = 20'



ALL PROPOSED GRADES
SHALL BE BASED ON EXISTING
CENTERLINE OF ROAD

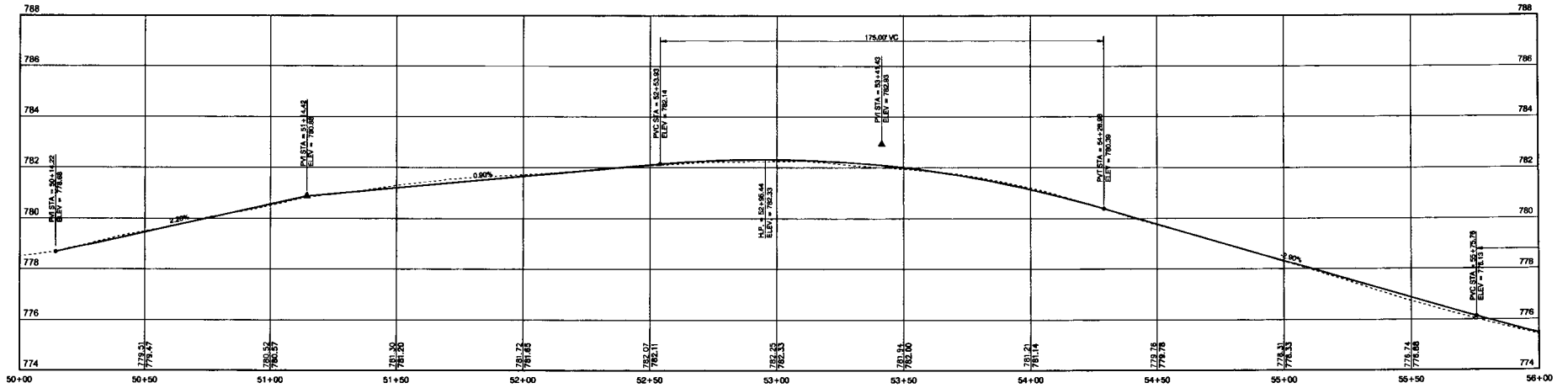

PROFILE VIEW
SCALE: 1" = 20'



MOHR & KERR ENGINEERING & LAND SURVEYING, P.C.
5901 N. Prospect Road, Suite 65
Peoria, Illinois 61614
www.mohrskerr.com
Office: (309) 692-6500
Fax: (309) 692-6501
Professional Design Firm #184.005061

REV.	DATE	DESCRIPTION OF REVISION	CHECKED

SURVEYED	CTG
DRAWN	MTH
CHECKED	SDK
SCALE	1" = 20'
DATE	05-29-16

CLIENT:
**ROADWAY IMPROVEMENTS
COLUMBINE DR.
CITY OF PEORIA, IL**

TITLE:
**PLAN VIEW
(FOR REFERENCE ONLY)**

PROJECT NO.	18-085
SHEET	3 OF 7
DRAWING NO.	3

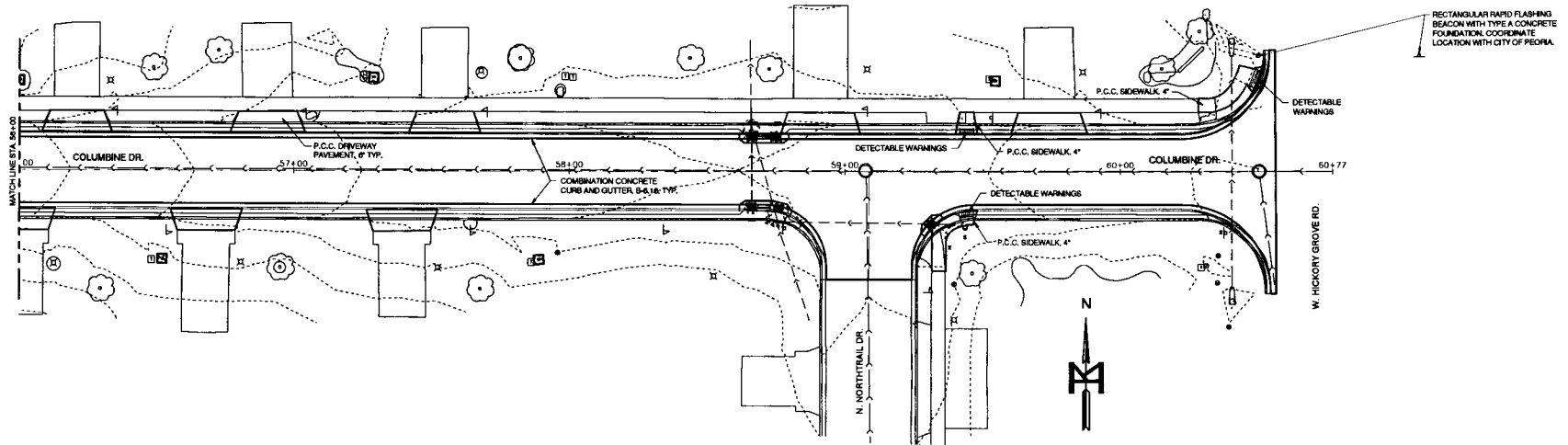

ALL PROPOSED GRADES SHALL BE BASED ON EXISTING CENTERLINE OF ROAD

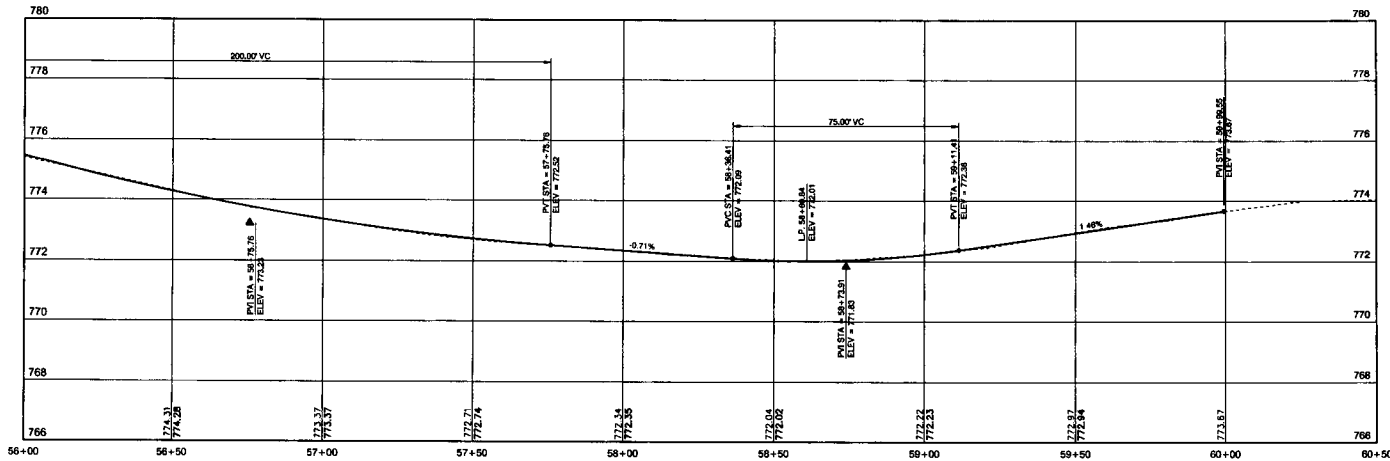

MOHR & KERR ENGINEERING & LAND SURVEYING, P.C.
5901 N. Prospect Road, Suite 88
Peoria, Illinois 61614
www.mohrlandkerr.com

Office: (309) 692-2500
Fax: (309) 692-4501
Professional Design Firm #184.005001

DESIGNED	DATE	NATURE OF REVISION	CHECKED	DATE

SURVEYED	CTG	CLIENT:
DRAWN	MTH	ROADWAY IMPROVEMENTS
CHECKED	BDK	COLUMBINE DR.
		CITY OF PEORIA, IL
SCALE	1" = 20'	TITLE:
DATE	05-26-19	

PROJECT NO.	16-085
SHEET	4 OF 7
DRAWING NO.	4



MOHR & KERR ENGINEERING & LAND SURVEYING, P.C.
 5801 N Prospect Road, Suite 65
 Peoria, Illinois 61614
 Phone: (309) 692-4500
 Fax: (309) 692-4501
 Office: (309) 692-4500
 Professional Design Firm # 184 005081
 www.mohr-kerr.com

REV.	DATE	BY	CHKD.	DATE	DESCRIPTION
1	05-26-16				

SHEETED CIG
 DRAWN LKH
 CHECKED SKK
 SCALE 1" = 5'
 DATE 05-26-16

ROADWAY IMPROVEMENTS
 COLUMBINE DR.
 CITY OF PEORIA, IL
 CLIENT: TITLE: STORM SEWER
 (FOR REFERENCE ONLY)
 PROJECT NO. 14-086
 SHEET 5 OF 7
 DRAWING NO. 5

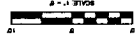
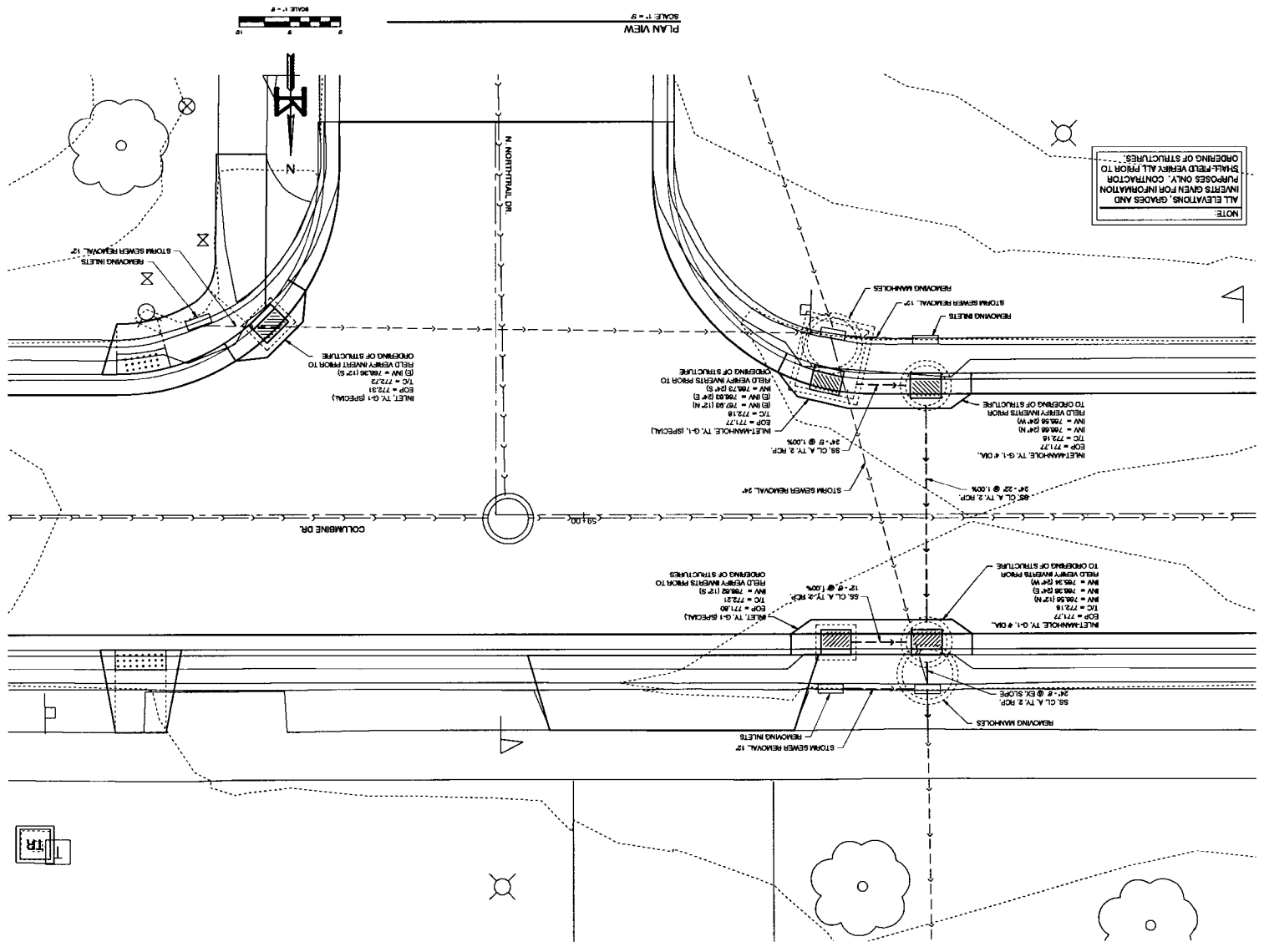

SCALE: 1" = 5'





MOHR & KERR ENGINEERING & LAND SURVEYING, P.C.
 5901 N. Prospect Road, Suite 88
 Peoria, Illinois 61614
 Phone: (309) 692-8501
 Office: (309) 692-8500
 Professional Design Firm # 144-005081
 www.mohr-kerr.com

DATE	05-28-18
SUBMITTED	
CITY	
WITH	
CHECKED	
SCALE	
NUMBER OF SHEETS	
TITLE	

ROADWAY IMPROVEMENTS
COLUMBIANE DR.
CITY OF PEORIA, IL

DRAWING NO. 7
 SHEET 7 OF 7
 PROJECT NO. 14005

INLET MANHOLE, TY. G-1 (SPECIAL)
 SCALE: 1" = 1'

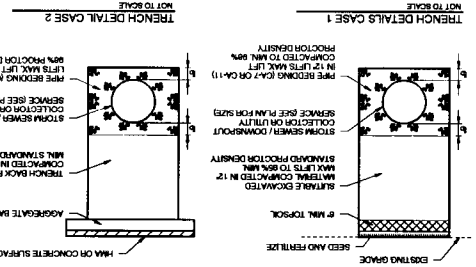
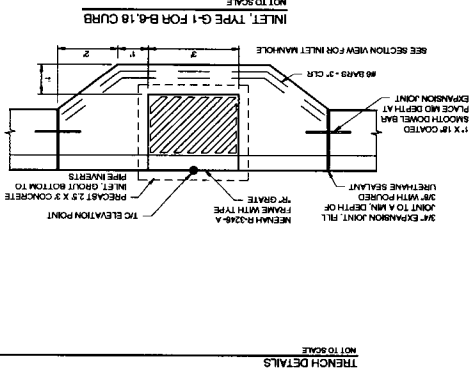
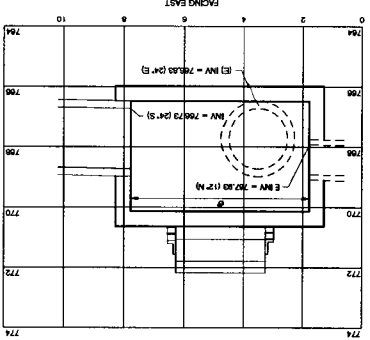
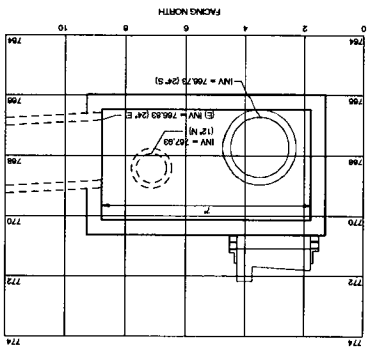

GENERAL NOTES:

1. THE CURB AND GUTTER SHALL BE CONCRETE WITH A MINIMUM STRENGTH OF 4000 PSI AND SHALL BE FINISHED WITH A BROOM FINISH.
2. EXPOSED SURFACES SHALL BE FINISHED WITH A BROOM FINISH.
3. ALL CURB AND GUTTER SHALL BE FINISHED WITH A BROOM FINISH.
4. THE CURB AND GUTTER SHALL BE FINISHED WITH A BROOM FINISH.
5. THE CURB AND GUTTER SHALL BE FINISHED WITH A BROOM FINISH.
6. THE CURB AND GUTTER SHALL BE FINISHED WITH A BROOM FINISH.
7. THE CURB AND GUTTER SHALL BE FINISHED WITH A BROOM FINISH.

ITEM NO.	DESCRIPTION	QTY	UNIT
1	CONCRETE	1.00	CU YD
2	REINFORCING BARS	1.00	TON
3	FORMWORK	1.00	SQ YD
4	LABOR	1.00	HOUR
5	EQUIPMENT	1.00	HOUR

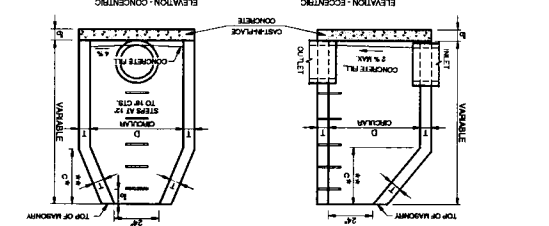
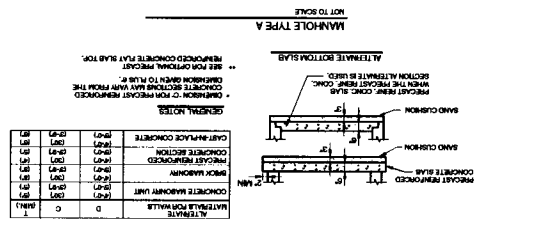
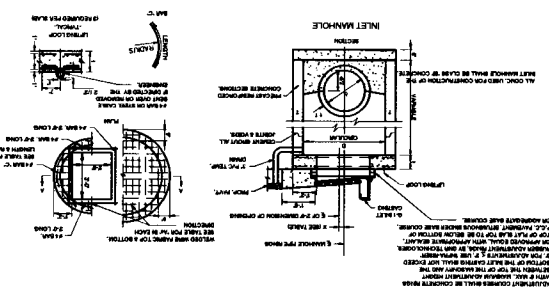

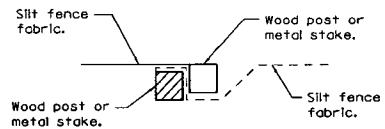

STEP 1

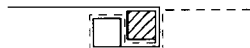

STEP 2

ATTACHING TWO SILT FILTER FENCES
(Not applicable for J-hooks)

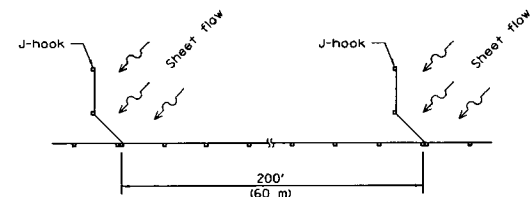

SILT FILTER J-HOOK PLACEMENT

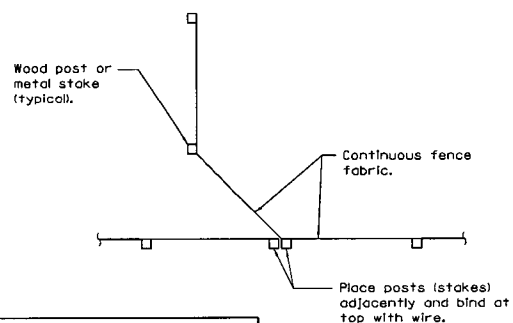

J-HOOK

Illinois Department of Transportation

PASSED January 1, 2013

ENGINEER OF POLICY AND PROCEDURES

APPROVED January 1, 2013

ENGINEER OF DESIGN AND ENVIRONMENT

15-1-17

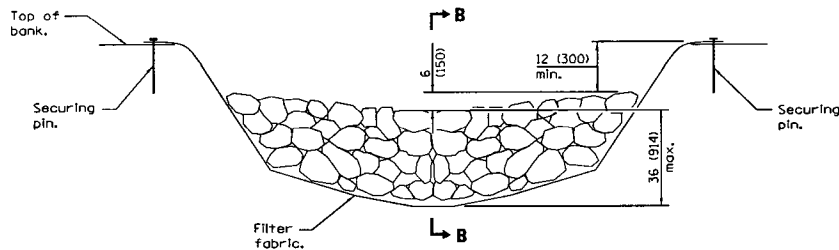

ELEVATION

• When the ditch check is within the clear zone and the road is open to traffic, the traffic approach slope of the aggregate shall be 1:4 (V:H).

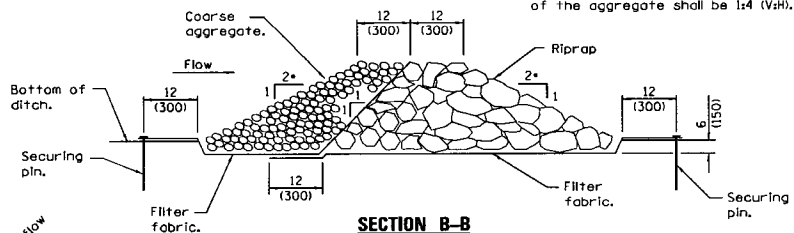

SECTION B-B

AGGREGATE DITCH CHECK

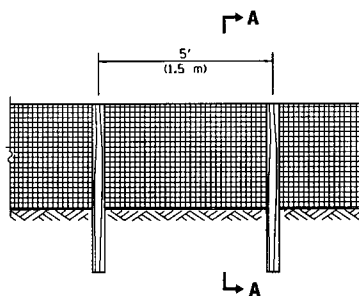

ELEVATION

SILT FILTER FENCE AS A PERIMETER EROSION BARRIER

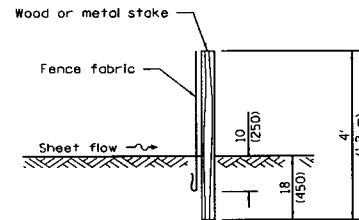

SLICE METHOD

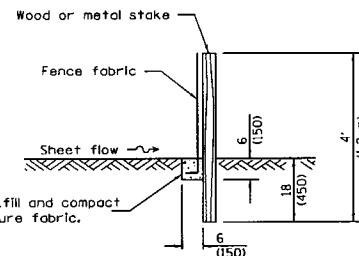

TRENCH METHOD

SECTION A-A

Excavate, backfill and compact trench to secure fabric.

GENERAL NOTES

The installation details and dimensions shown for perimeter erosion barriers shall also apply for Inlet and pipe protection.

All dimensions are in inches (millimeters) unless otherwise shown.

DATE	REVISIONS
1-1-13	Corrected notation for flowline (E) on SEDIMENT BASIN ELEVATION.
1-1-12	Omitted hay/straw perimeter barrier. Added SLICE METHOD to SECTION A-A.

TEMPORARY EROSION CONTROL SYSTEMS

(Sheet 1 of 2)

STANDARD 280001-07

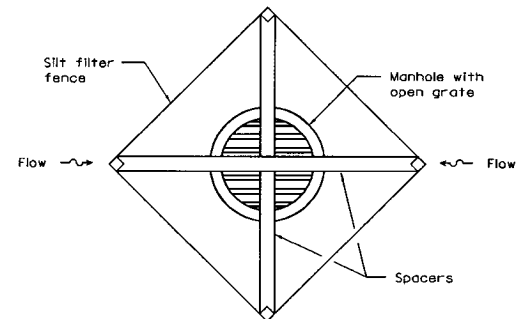
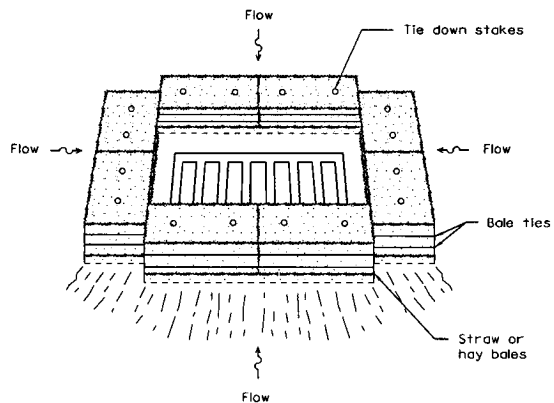
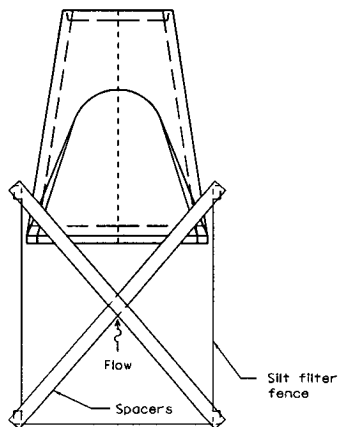
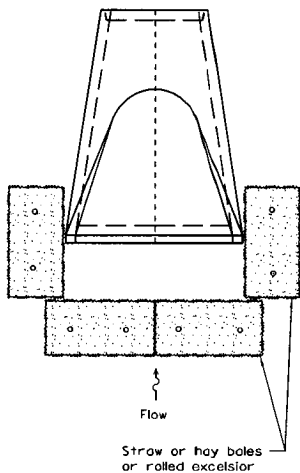

INLET AND PIPE PROTECTION

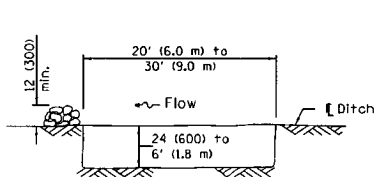

The performance of the basin will improve if put into a series.

ELEVATION

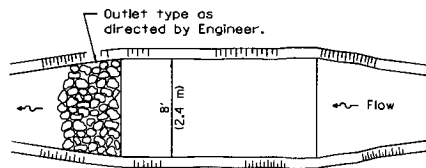

The long dimension should be parallel with the direction of the flow. Accumulated slilt shall be removed anytime the basins become 75% filled.

PLAN

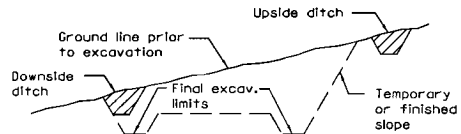

TYPICAL CUT CROSS-SECTION

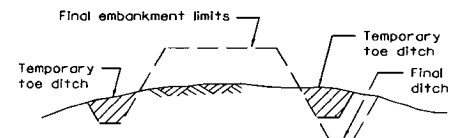

TYPICAL FILL CROSS-SECTION

TEMPORARY DITCHES FOR CUT & FILL SECTIONS

SEDIMENT BASIN

Illinois Department of Transportation	
PASSED	January 1, 2013
Michael Beard ENGINEER OF POLICY AND PROCEDURES	
APPROVED	January 1, 2013
ENGINEER OF DESIGN AND ENVIRONMENT	

152024
68-1-1 (2012)

TEMPORARY EROSION CONTROL SYSTEMS

(Sheet 2 of 2)

STANDARD 280001-07

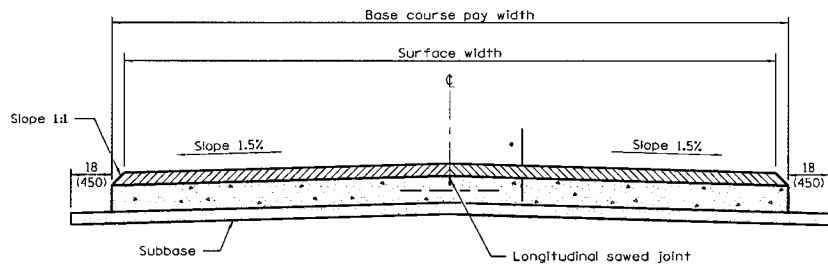

* HMA binder and surface courses

SECTION A-A
(TYPICAL 2 LANE WITH SHOULDERS)

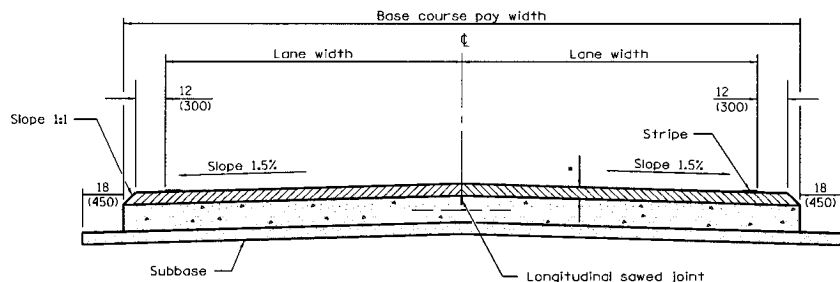

ALTERNATE SECTION A-A
(TYPICAL 2 LANE WITH SHOULDERS)

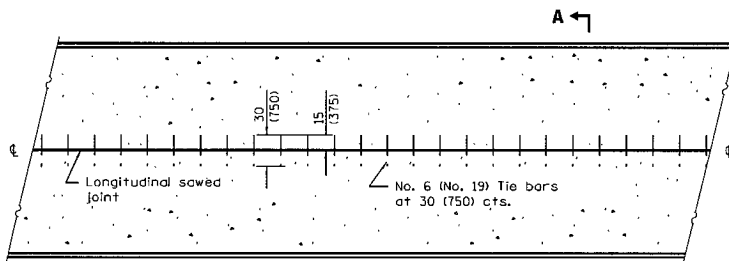

PLAN

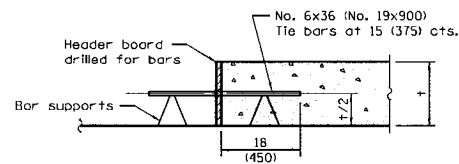

TRANSVERSE CONSTRUCTION JOINT

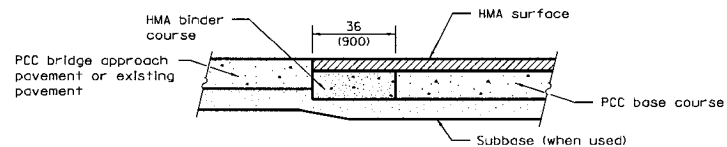

**LONGITUDINAL SECTION SHOWING
CONSTRUCTION ADJACENT
TO PCC BRIDGE APPROACH PAVEMENT
OR EXISTING PAVEMENT**

GENERAL NOTES

The longitudinal sawed joint shall be as detailed on Standard 420001 except the sawed groove does not require sealing.

All dimensions are in inches (millimeters) unless otherwise shown.

Illinois Department of Transportation

PASSED January 1, 2008
Scott Smith
 ENGINEER OF POLICY AND PROCEDURES

APPROVED January 1, 2008
Ken E. Man
 ENGINEER OF DESIGN AND ENVIRONMENT

ISSUED 1-1-97

DATE	REVISIONS	PCC BASE COURSE WITH HMA BINDER AND SURFACE COURSES
1-1-08	Switched units to English (metric).	
1-1-07	Switched to Hot-Mix Asphalt (HMA) terminology.	STANDARD 353001-04

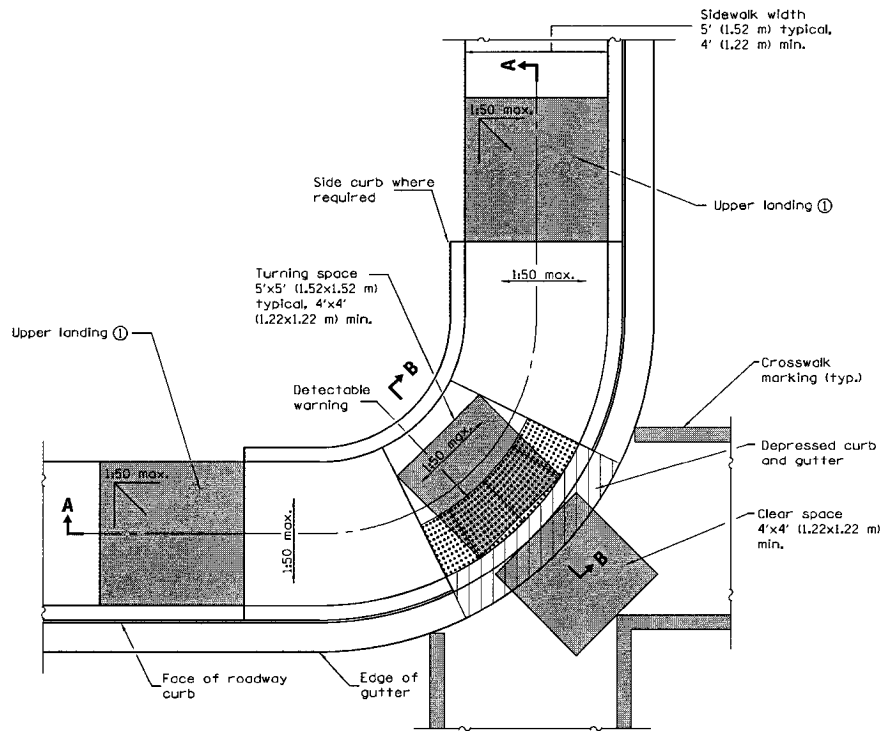

CORNER PARALLEL CURB RAMP

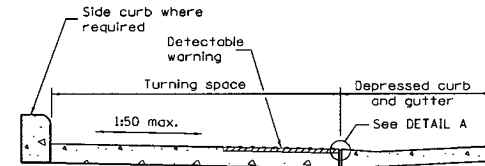

SECTION B-B

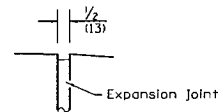

DETAIL A

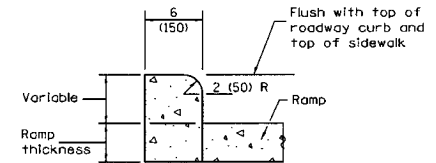

SIDE CURB DETAIL

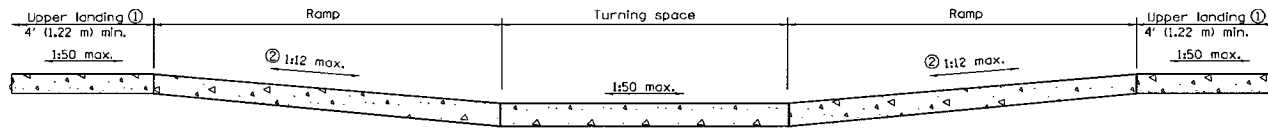

SECTION A-A

- ① Upper landing(s) not required for ramp slopes flatter than 1:20.
- ② The running slope of the curb ramp shall not require the ramp length to exceed 15' (4.5 m).

GENERAL NOTES

All slope ratios are expressed as units of vertical displacement to units of horizontal displacement (V:H).

Where the turning space is constrained on a side opposite a ramp, the minimum length of the turning space in the direction of the ramp-run shall be 5' (1.52 m).

Where 1:50 maximum slope is shown, 1:64 is preferred.

See Standard 606001 for details of depressed curb adjacent to curb ramp.

All dimensions are in inches (millimeters) unless otherwise shown.

CORNER PARALLEL CURB RAMPS FOR SIDEWALKS

STANDARD 424011-02

Illinois Department of Transportation

PASSED January 1, 2015
Michael Board
 ENGINEER OF POLICY AND PROCEDURES

APPROVED January 1, 2015
[Signature]
 ENGINEER OF DESIGN AND ENVIRONMENT

1515151-1-12

DATE	REVISIONS
1-1-15	Changed 'Lower landing' to 'Turning space'. Added x-walk markings. Added note ②.
1-1-13	Revised General Notes.

DESIGNER NOTES:

1. Include State STD# 606001 for combination concrete curb and gutter details.
2. Include State STD# 62001 for pavement joints.
3. Include State STD# 60270 for grate type in plans.
4. Include District CADD Standard for precast reinforced concrete flat slab top.
5. Include District CADD Standard for frame and grates and specify grate type in plans.
6. Include District CADD Standard for precast reinforced concrete flat slab top.
7. The designer should include pavement removal quantities when the apron requires pavement removal.
8. Specify diameter of inlet manhole in plans.

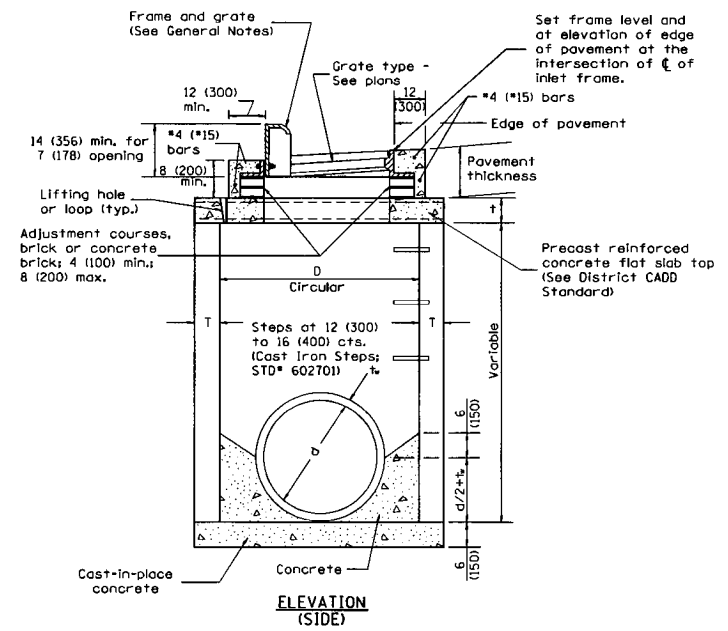
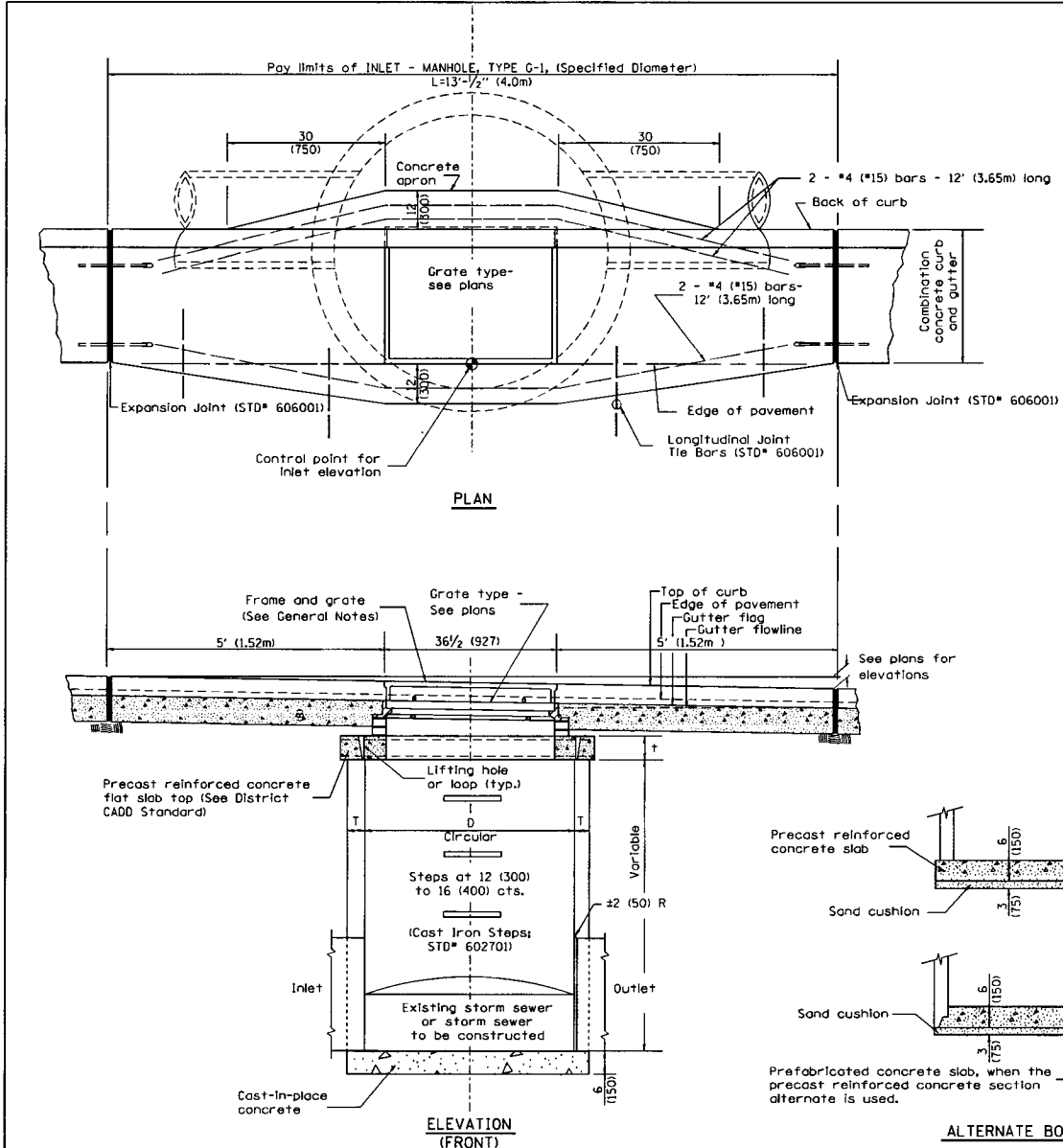

TABLE

D	T	±
4' (1.2m)	5 (125)	6 (150)
5' (1.5m)	6 (150)	8 (200)
6' (1.8m)	7 1/4 (195)	8 (200)
8' (2.4m)	9 (225)	10 (250)

- GENERAL NOTES
1. Inlet-manhole construction shall be in accordance with Section 602 of the Standard Specifications.
 2. Combination concrete curb and gutter shall be constructed in accordance with Section 606 of the Standard Specifications.
 3. See District CADD Standard 604001-D4 for frame and grates.
 4. See District CADD Standard for precast reinforced concrete flat slab top.

STATE OF ILLINOIS
DEPARTMENT OF TRANSPORTATION

INLET-MANHOLE, TYPE G-1

01-01-97	REINLM, B-4.05, NEW REVISION BOX		
10-99	REVISION TO GENERAL NOTES	J.A.	
02-00	REVISION TO DESIGNER NOTES	J.A.	
10-16-06	REVISED TO 2007 SPEC.	M.A.	

NOT TO SCALE

All dimensions are in inches (millimeters) unless otherwise noted.

PA. RTR.	SECTION	COUNTY	TOTAL SHEETS	SHEET NO.
CONTRACT NO.				
CADD STD. 602021-D4				
FED. ROAD DIST. NO. ILLINOIS FED. AID PROJECT				

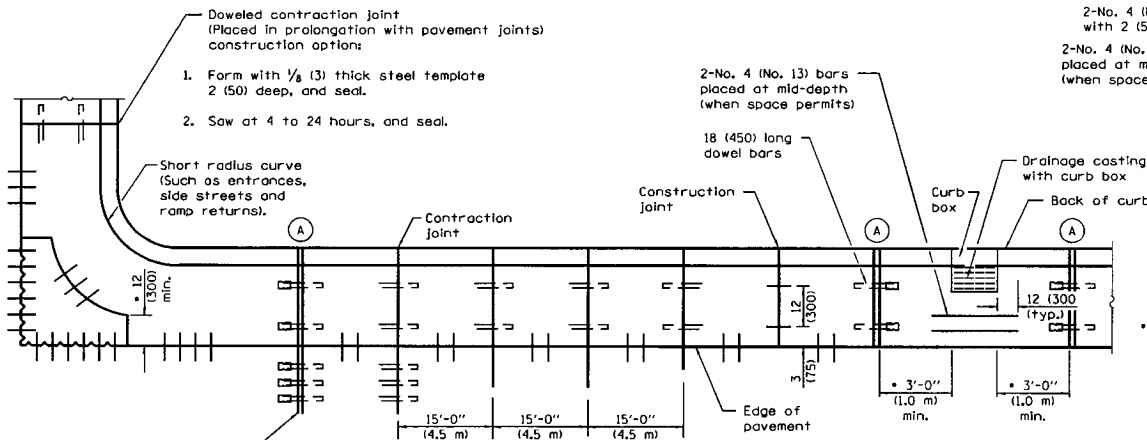

PLAN
ADJACENT TO PCC PAVEMENT OR PCC BASE COURSE

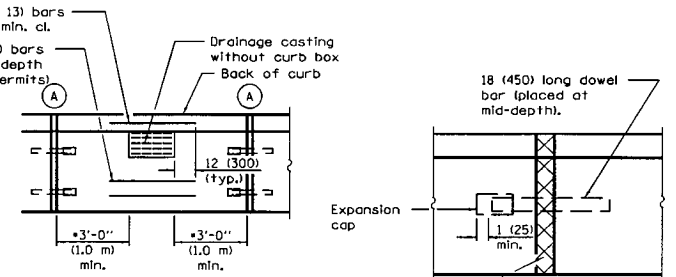

DETAIL (A)
EXPANSION JOINT

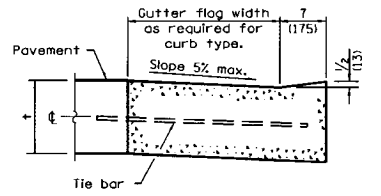

DEPRESSED CURB ADJACENT TO CURB RAMP ACCESSIBLE TO THE DISABLED

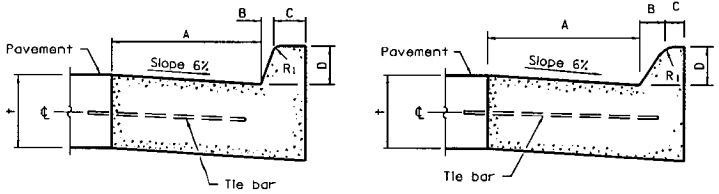

BARRIER CURB

MOUNTABLE CURB

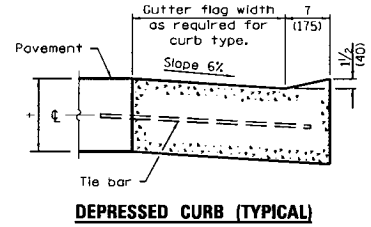

DEPRESSED CURB (TYPICAL)

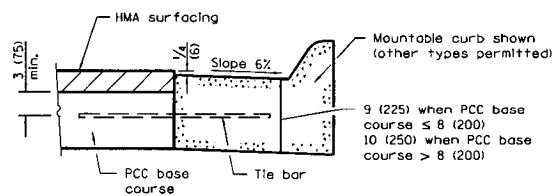

ADJACENT TO PCC BASE COURSE WITH HMA SURFACING

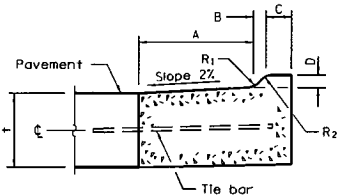

M-2.06 (M-5.15) and M-2.12 (M-5.30)

TYPE	A	B	C	D	R ₁
B-6.06* (B-15.15)	6 (150)	1 (25)	6 (150)	6 (150)	1 (25)
B-6.12 (B-15.3)	12 (300)	1 (25)	6 (150)	6 (150)	1 (25)
B-6.18 (B-15.45)	18 (450)	1 (25)	6 (150)	6 (150)	1 (25)
B-6.24 (B-15.60)	24 (600)	1 (25)	6 (150)	6 (150)	1 (25)
B-9.12 (B-22.30)	12 (300)	2 (50)	5 (125)	9 (225)	1 (25)
B-9.18 (B-22.45)	18 (450)	2 (50)	5 (125)	9 (225)	1 (25)
B-9.24 (B-22.60)	24 (600)	2 (50)	5 (125)	9 (225)	1 (25)

TYPE	A	B	C	D	R ₁	R ₂
M-2.06 (M-5.15)	6 (150)	2 (50)	4 (100)	2 (50)	3 (75)	2 (50)
M-2.12 (M-5.30)	12 (300)	2 (50)	4 (100)	2 (50)	3 (75)	2 (50)
M-4.06 (M-10.15)	6 (150)	4 (100)	3 (75)	4 (100)	3 (75)	NA
M-4.12 (M-10.30)	12 (300)	4 (100)	3 (75)	4 (100)	3 (75)	NA
M-4.18 (M-10.45)	18 (450)	4 (100)	3 (75)	4 (100)	3 (75)	NA
M-4.24 (M-10.60)	24 (600)	4 (100)	3 (75)	4 (100)	3 (75)	NA
M-6.06 (M-15.15)	6 (150)	6 (150)	2 (50)	6 (150)	2 (50)	NA
M-6.12 (M-15.30)	12 (300)	6 (150)	2 (50)	6 (150)	2 (50)	NA
M-6.18 (M-15.45)	18 (450)	6 (150)	2 (50)	6 (150)	2 (50)	NA
M-6.24 (M-15.60)	24 (600)	6 (150)	2 (50)	6 (150)	2 (50)	NA

* For corner islands only.

Illinois Department of Transportation
 PASSED January 1, 2015
 Michael Brand
 ENGINEER OF POLICY AND PROCEDURES
 APPROVED January 1, 2015
 ENGINEER OF DESIGN AND ENVIRONMENT

DATE	REVISIONS
1-1-15	Added B-6.06 (B-15.15) barrier curb and gutter to table (corner islands only).
1-1-13	Added general note regarding requirement for dowel bars.

GENERAL NOTES

The bottom slope of combination curb and gutter constructed adjacent to pcc pavement shall be the same slope as the subbase or 6% when subbase is omitted.

+ = Thickness of pavement.

Longitudinal joint tie bars shall be No. 6 (No. 19) at 24 (600) centers in accordance with details for longitudinal construction joint shown on Standard 420001.

A minimum clearance of 2 (50) between the end of the tie bar and the back of the curb shall be maintained.

The dowel bars shown in contraction joints will only be required for monolithic construction.

See Standard 606301 for details of corner islands.

All dimensions are in inches (millimeters) unless otherwise shown.

CONCRETE CURB TYPE B AND COMBINATION CONCRETE CURB AND GUTTER
 (Sheet 1 of 2)
STANDARD 606001-06

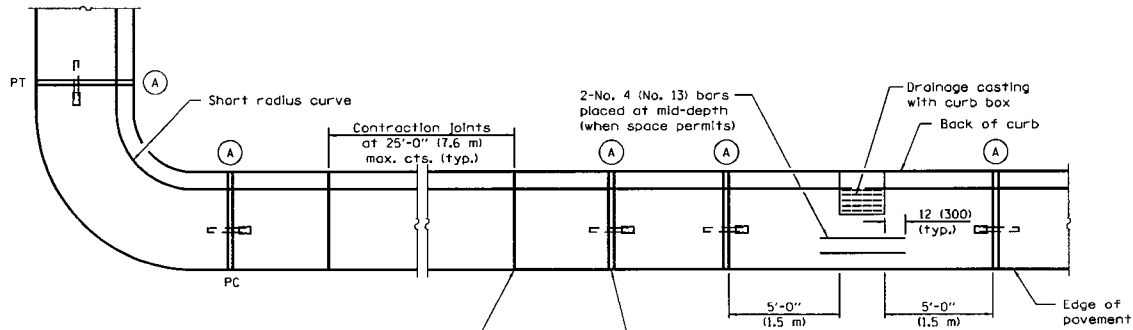

Undoweled contraction joint (typ.) construction options:

1. Form with 1/4 (3) thick steel template 2 (50) deep, and seal.
2. Saw 2 (50) deep at 4 to 24 hours, and seal.
3. Insert 3/4 (20) thick preformed joint filler full depth and width.

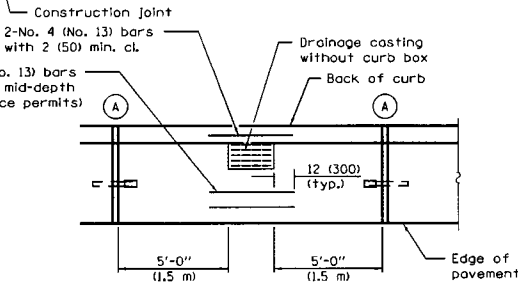

PLAN

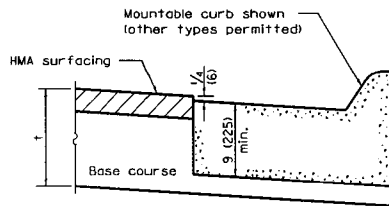

ON DISTURBED SUBGRADE

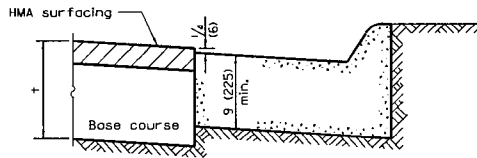

ON UNDISTURBED SUBGRADE

ADJACENT TO FLEXIBLE PAVEMENT

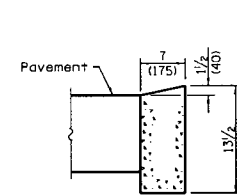

DEPRESSED CURB

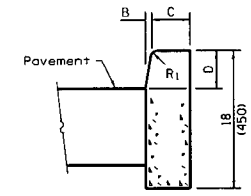

BARRIER CURB

ADJACENT TO FLEXIBLE PAVEMENT

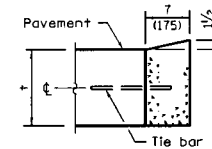

DEPRESSED CURB

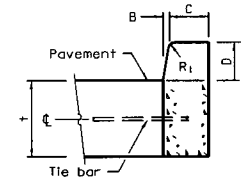

BARRIER CURB

ADJACENT TO PCC PAVEMENT OR PCC BASE COURSE

CONCRETE CURB TYPE B

**CONCRETE CURB TYPE B
AND COMBINATION
CONCRETE CURB AND GUTTER**
(Sheet 2 of 2)

STANDARD 606001-06

Illinois Department of Transportation

PASSED January 1, 2015

Michael Brand
ENGINEER OF POLICY AND PROCEDURES

APPROVED January 1, 2015

ENGINEER OF DESIGN AND ENVIRONMENT

ISSUED 1-1-97

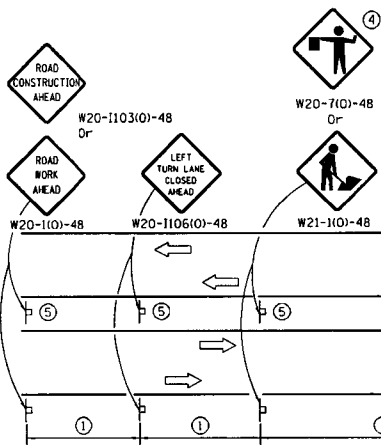

LEFT TURN LANE OR CENTER MEDIAN OPERATIONS

- ① Refer to SIGN SPACING TABLE for distance.
- ② Required for speed > 40 mph.
- ③ Cones at 25' (8 m) centers for 250' (75 m). Additional cones may be placed at 50' (15 m) centers. When drums or Type I or Type II barricades are used, the interval between devices may be doubled.
- ④ Use flagger sign only when flagger is present.
- ⑤ Omit this sign when median is less than 10' (3 m) or for bi-directional turn lanes.
- ⑥ Cones, drums or barricades at 20' (6 m) centers in taper.
- ⑦ Advanced arrow board required for speeds > 45 mph.
- ⑧ Three Type II barricades, drums or vertical barricades at 50' (15 m) centers.

SYMBOLS

- Work area
- Cone, drum or barricade
- Sign on portable or permanent support
- Arrow board
- Barricade or drum with flashing light
- Flagger with traffic control sign

SIGN SPACING	
Posted Speed	Sign Spacing
55	500' (150 m)
50-45	350' (100 m)
<45	200' (60 m)

SHOULDER OPERATIONS

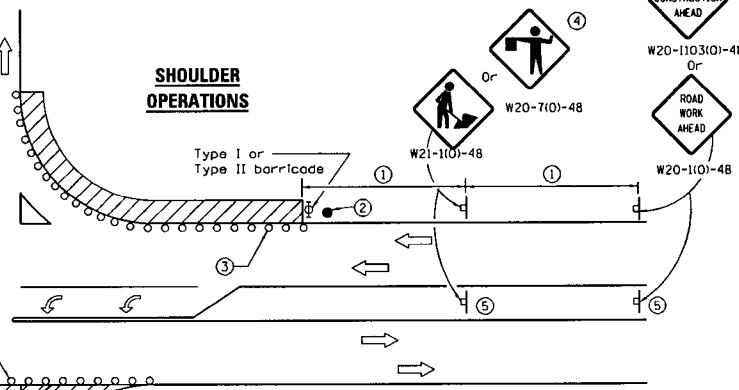

CORNER ISLAND OPERATIONS

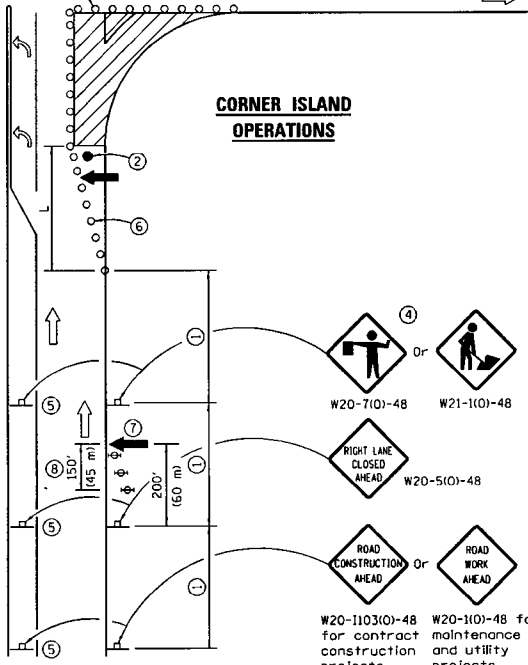

GENERAL NOTES

This Standard is used where at any time, day or night, any vehicle, equipment, workers or their activities encroach on the pavement during shoulder operations or where construction requires lane closures in an urban area.

Calculate L as follows:

SPEED LIMIT

FORMULAS

40 mph (70 km/h) or less:

English (Metric)
 $L = \frac{WS^2}{60}$ $L = \frac{WS^2}{150}$

45 mph (80 km/h) or greater:

$L = (W)(S)$ $L = 0.65(W)(S)$

W = Width of offset in feet (meters).

S = Normal posted speed mph (km/h).

All dimensions are in inches (millimeters) unless otherwise shown.

Illinois Department of Transportation

APPROVED *[Signature]* April 11, 2016
 ENGINEER OF SAFETY ENGINEERING

APPROVED *[Signature]* April 11, 2016
 ENGINEER OF DESIGN AND ENVIRONMENT

ISSUED 1-1-97

DATE	REVISIONS
4-1-16	Corrected sign number for LEFT TURN LANE CLOSED AHEAD.
1-1-14	Added devices at arrow board upstream from taper.
	Rev. workers sign number.

URBAN LANE CLOSURE, MULTILANE INTERSECTION

STANDARD 701701-10

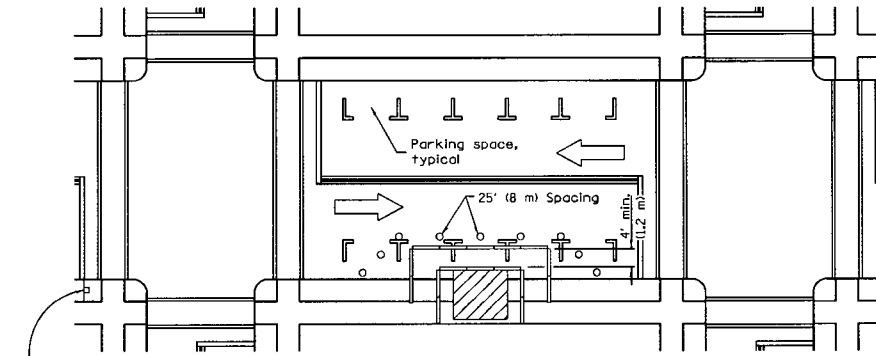

① Omit whenever duplicated by road work traffic control.

① ROAD CONSTRUCTION AHEAD
W20-1103(O)-48 for contract construction projects

Or
① ROAD WORK AHEAD
W20-110-48 for maintenance and utility projects

SIDEWALK DIVERSION

GENERAL NOTES

This Standard is used where, at any time, pedestrian traffic must be rerouted due to work being performed.

This Standard must be used in conjunction with other Traffic Control & Protection Standards when roadway traffic is affected.

Temporary facilities shall be detectable and accessible.

The temporary pedestrian facilities shall be provided on the same side of the closed facilities whenever possible.

The SIDEWALK CLOSED / USE OTHER SIDE sign shall be placed at the nearest crosswalk or intersection to each end of the closure. Where the closure occurs at a corner, the signs shall be erected on the corners across the street from the closure. The SIDEWALK CLOSED signs shall be used at the ends of the actual closures.

Type III barricades and R11-2-4830 signs shall be positioned as shown in "ROAD CLOSED TO ALL TRAFFIC" detail on Standard 701901.

All dimensions are in Inches (millimeters) unless otherwise shown.

- SYMBOLS**
- Work area
 - Sign on portable or permanent support
 - Barricade or drum
 - Cone, drum or barricade
 - Type III barricade
 - Detectable pedestrian channelizing barricade

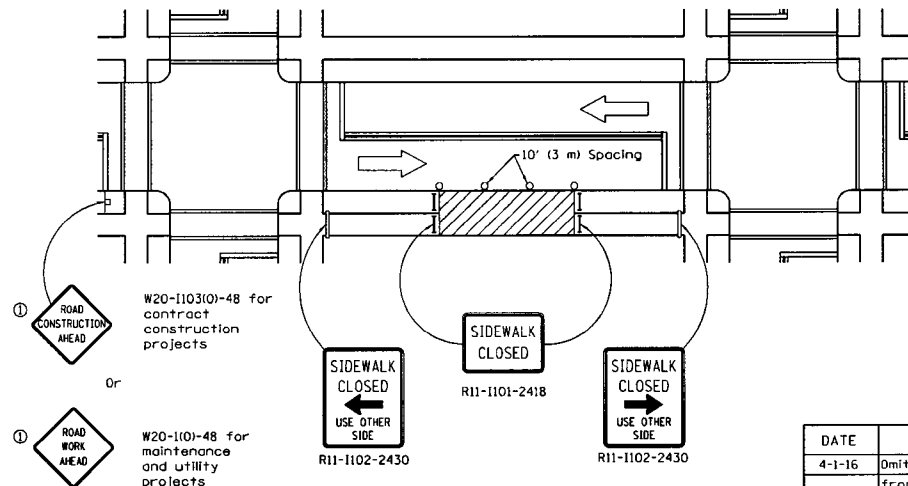

① ROAD CONSTRUCTION AHEAD
W20-1103(O)-48 for contract construction projects

Or
① ROAD WORK AHEAD
W20-110-48 for maintenance and utility projects

SIDEWALK CLOSED
←
USE OTHER SIDE
R11-1102-2430

SIDEWALK CLOSED
R11-1101-2418

SIDEWALK CLOSED
→
USE OTHER SIDE
R11-1102-2430

SIDEWALK CLOSURE

Illinois Department of Transportation

APPROVED *[Signature]* April 1, 2016
ENGINEER OF SAFETY ENGINEERING

APPROVED *[Signature]* April 1, 2016
ENGINEER OF DESIGN AND ENVIRONMENT

ISSUED 1-1-19

DATE	REVISIONS
4-1-16	Omitted orange safety fence from standard as this is covered in the std. spec.
1-1-12	Added SIDEWALK DIVERSION.
	Modified appearance of plan views. Renamed Std.

SIDEWALK, CORNER OR CROSSWALK CLOSURE

(Sheet 1 of 2)

STANDARD 701801-06

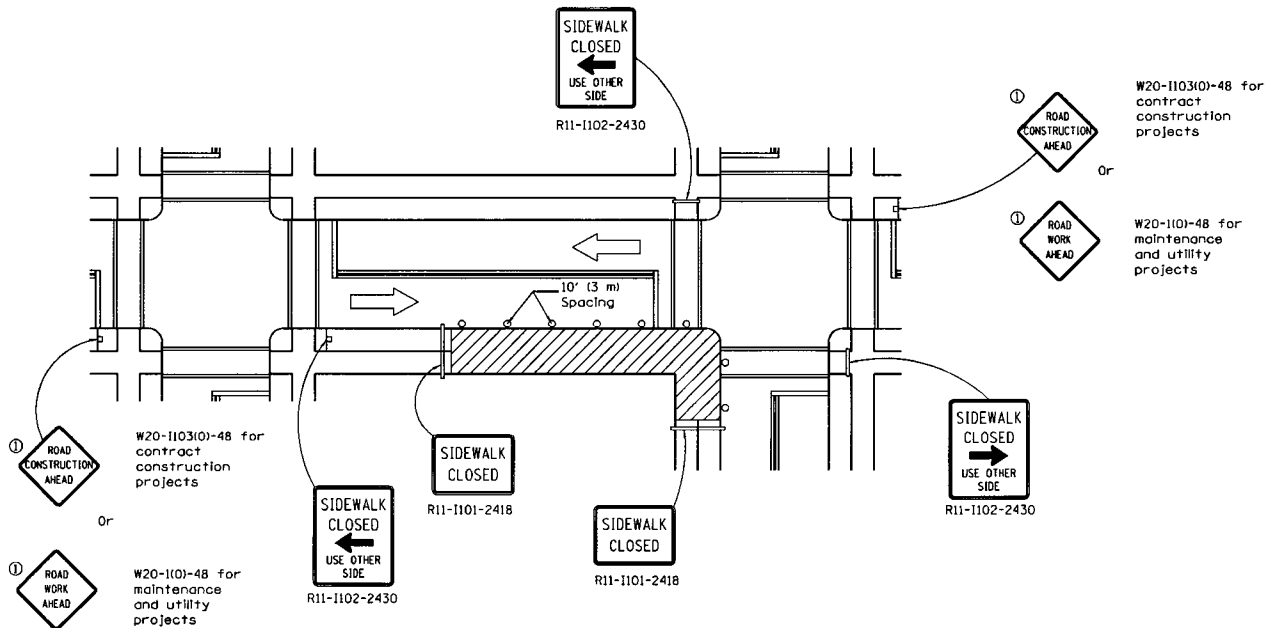

CORNER CLOSURE

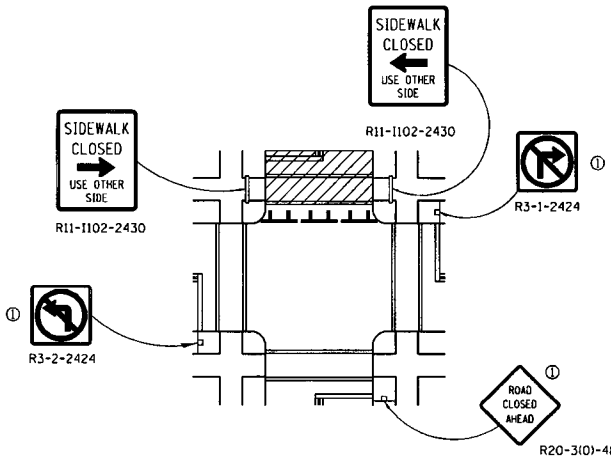

CROSSWALK CLOSURE

Illinois Department of Transportation

APPROVER: _____ Apr 11, 2016
 ENGINEER OF SAFETY ENGINEERING

APPROVED: _____ Apr 11, 2016
 ENGINEER OF DESIGN AND ENVIRONMENT

ISSUED 1-1-95

SIDEWALK, CORNER OR CROSSWALK CLOSURE

(Sheet 2 of 2)

STANDARD 701801-06

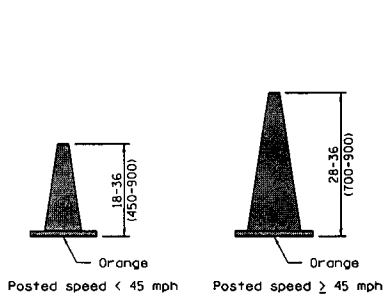

CONE FOR DAYTIME

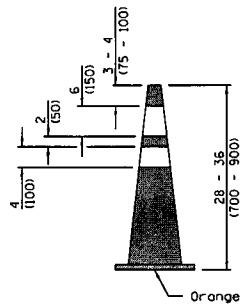

REFLECTORIZED CONE FOR NIGHTTIME

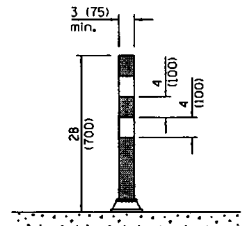

FLEXIBLE DELINEATOR

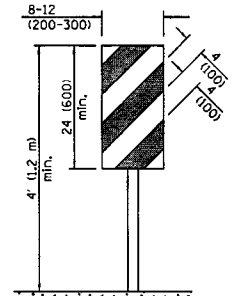

VERTICAL PANEL POST MOUNTED

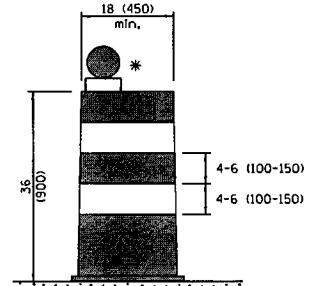

DRUM

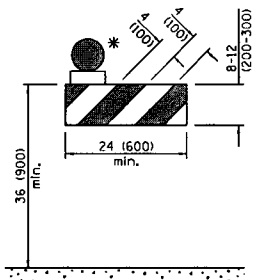

TYPE I BARRICADE

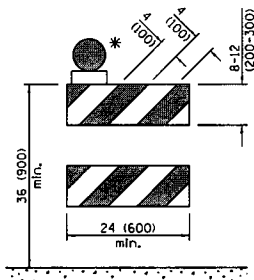

TYPE II BARRICADE

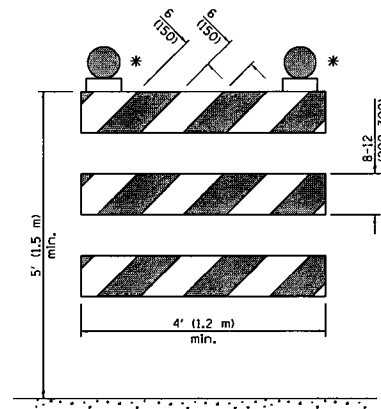

TYPE III BARRICADE

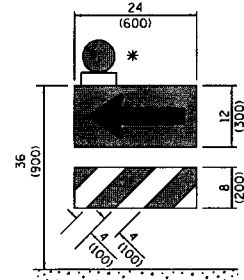

DIRECTION INDICATOR BARRICADE

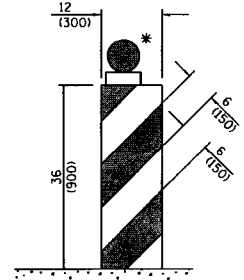

VERTICAL BARRICADE

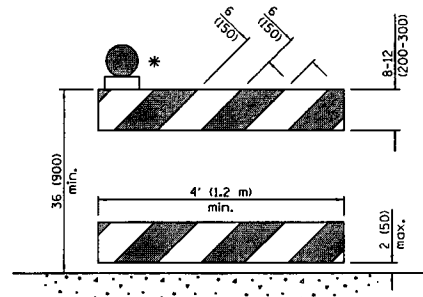

DETECTABLE PEDESTRIAN CHANNELIZING BARRICADE

* Warning lights (if required)

GENERAL NOTES

All heights shown shall be measured above the pavement surface.

All dimensions are in inches (millimeters) unless otherwise shown.

Illinois Department of Transportation

APPROVED: *[Signature]* Apr 11, 2016
ENGINEER OF OPERATIONS

APPROVED: *[Signature]* Apr 11, 2016
ENGINEER OF DESIGN AND ENVIRONMENT

152855
24-1-1-05

DATE	REVISIONS
4-1-16	Add dim's to barricades. Rev. note for post mnt. signs.
	Rev. cone dtls. Add W12-I103.
1-1-15	Revised two sign numbers on sheet 2. Added note reg. PHOTO ENFORCED plaque.

TRAFFIC CONTROL DEVICES

(Sheet 1 of 3)

STANDARD 701901-05

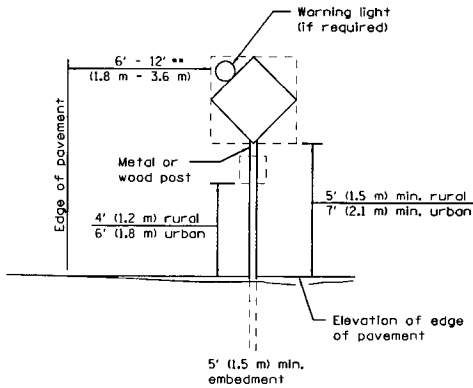

POST MOUNTED SIGNS

** When curb or paved shoulder are present this dimension shall be 24 (600) to the face of curb or 6' (1.8 m) to the outside edge of the paved shoulder.

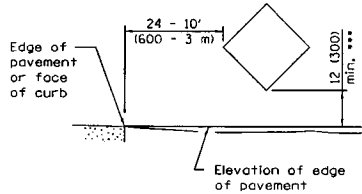

SIGNS ON TEMPORARY SUPPORTS

*** When work operations exceed four days, this dimension shall be 5' (1.5 m) min. If located behind other devices, the height shall be sufficient to be seen completely above the devices.

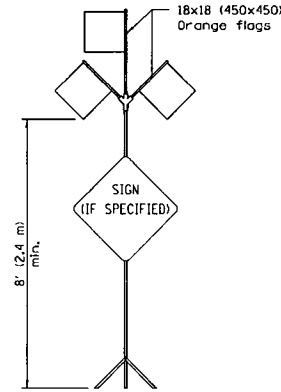

HIGH LEVEL WARNING DEVICE



W12-1103-4848

WIDTH RESTRICTION SIGN

XX'-XX'' width and X miles are variable.

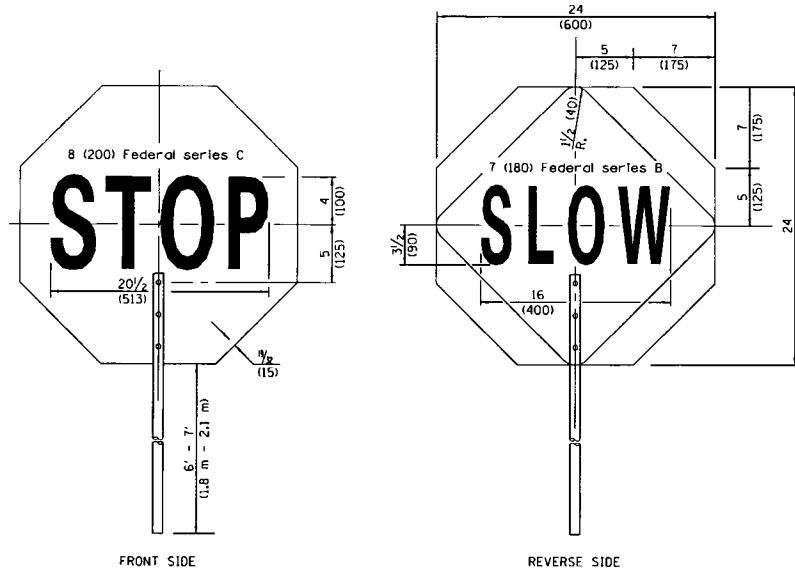

FLAGGER TRAFFIC CONTROL SIGN

ROAD
CONSTRUCTION
NEXT X MILES

G20-110410-6036

END
CONSTRUCTION

G20-110510-6024

This signing is required for all projects 2 miles (3200 m) or more in length.

ROAD CONSTRUCTION NEXT X MILES sign shall be placed 500' (150 m) in advance of project limits.

END CONSTRUCTION sign shall be erected at the end of the job unless another job is within 2 miles (3200 m).

Dual sign displays shall be utilized on multi-lane highways.

WORK LIMIT SIGNING

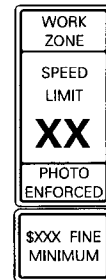

W21-111510-3618

R2-1-3648

R10-1108p-3618 ****

R2-1106p-3618

Sign assembly as shown on Standards or as allowed by District Operations.

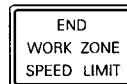

G20-110310-6036

This sign shall be used when the above sign assembly is used.

**HIGHWAY CONSTRUCTION
SPEED ZONE SIGNS**

**** R10-1108p shall only be used along roadways under the jurisdiction of the State.

**TRAFFIC CONTROL
DEVICES**

(Sheet 2 of 3)

STANDARD 701901-05

Illinois Department of Transportation

APPROVED April 1, 2016
ENGINEER OF OPERATIONS
APPROVED April 1, 2016
ENGINEER OF DESIGN AND ENVIRONMENT

ISSUED 781-1-87

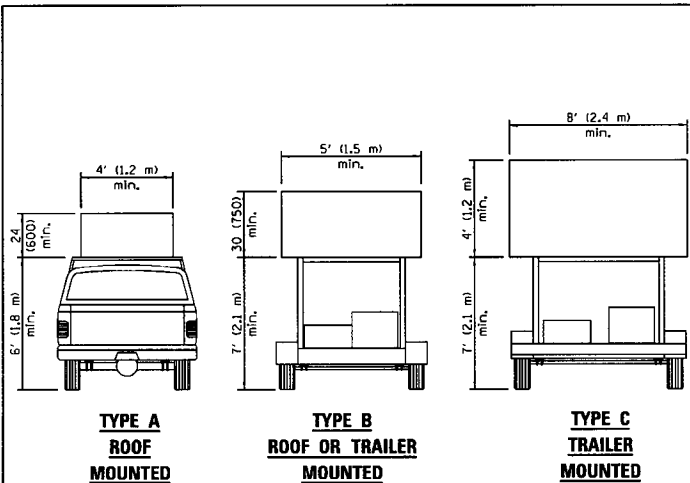

ARROW BOARDS

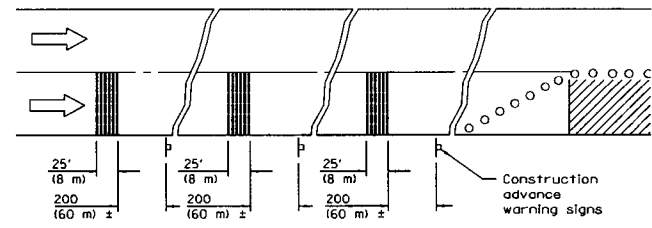
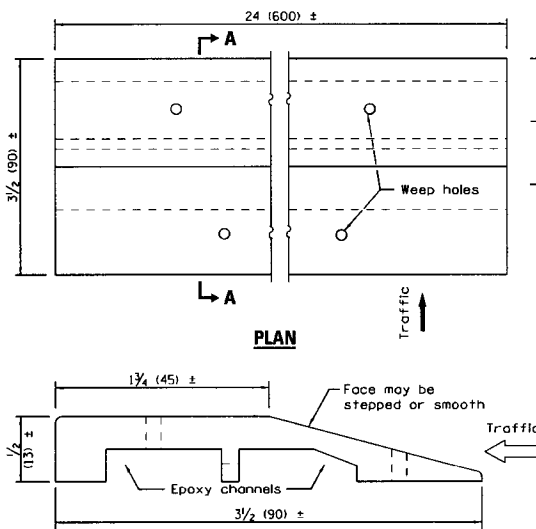

TEMPORARY RUMBLE STRIPS

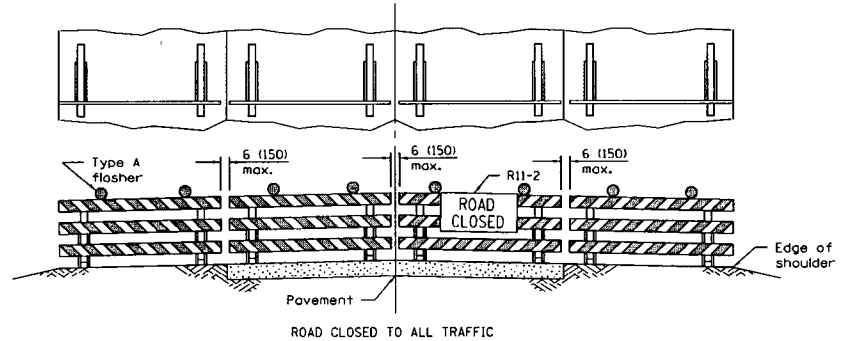

Reflectorized striping may be omitted on the back side of the barricades. If a Type III barricade with an attached sign panel which meets NCHRP 350 is not available, the sign may be mounted on an NCHRP 350 temporary sign support directly in front of the barricade.

**TYPICAL APPLICATIONS OF
TYPE III BARRICADES CLOSING A ROAD**

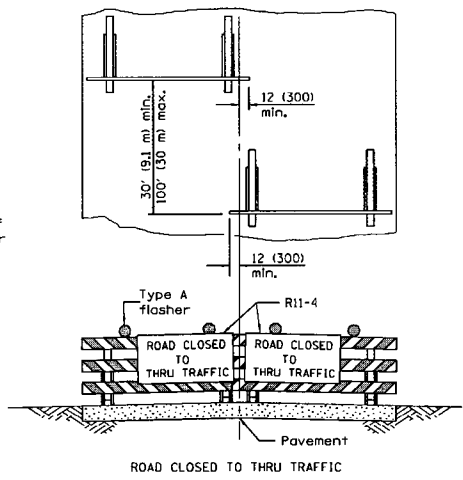

Reflectorized striping shall appear on both sides of the barricades. If a Type III barricade with an attached sign panel which meets NCHRP 350 is not available, the signs may be mounted on NCHRP 350 temporary sign supports directly in front of the barricade.

Illinois Department of Transportation

APPROVED April 1, 2016
John Allen
 ENGINEER OF OPERATIONS

APPROVED April 1, 2016
[Signature]
 ENGINEER OF DESIGN AND ENVIRONMENT

1505000
 44-1-1

**TRAFFIC CONTROL
DEVICES**

(Sheet 3 of 3)

STANDARD 701901-05